

Job Name:

Type:

Specification Grade 1-Circuit 120-Volt Track

Track Section

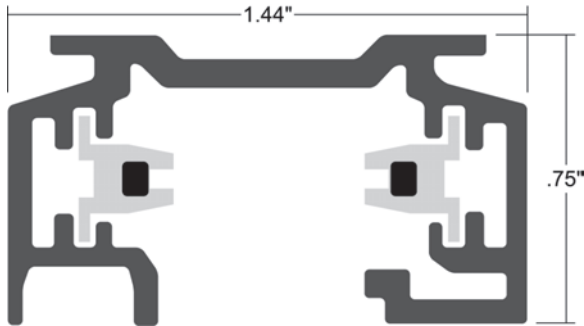

Track Section

- 4 ft. SG 4
- 8 ft. SG 8
- 12 ft. SG 12

Add suffix *B-Black, W-White, 1-Natural*.
 Custom lengths available. Please consult factory.

Components (Add suffix *B-Black, W-White, S-Silver*.)

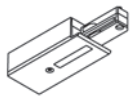

SG 11 (ground contact right)
SG 11L (ground contact left)
Live End Feed
 Used when energizing track from an outlet box or conduit feed.

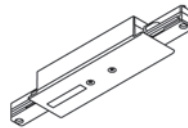

SG 14
Center Feed
 Used to join two sections of track together in a straight line. May be used as a feed point.

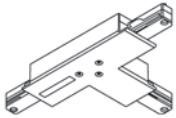

SG 36 (right)
SG 37 (left)
T Connector Feed
 Used to join three sections of track in a "T" configuration. May be used as a feed point.

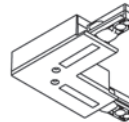

SG 24 (ground contact right)
SG 25 (ground contact left)
L Connector Feed
 Used to join two sections of track together at a 90° angle. May be used as a feed point.

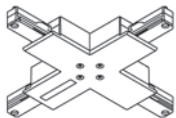

SG 38
X Connector Feed
 Used to join four sections of track together in an "X" configuration. May be used as a feed point.

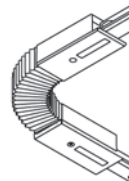

SG 23
Flex Connector
 Used to join two sections of track together to create angles from 0° to 180°. Can be flexed on horizontal or vertical planes.

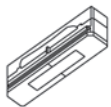

SG 21
Straight Connector
 Used to join two sections of track together in a straight line.



SG 41
End Caps
 Used to end any open configuration of track.



XTSAJ 10
Conduit Adapter
 Used to attached power to any live feed.



SG 15
End Feed Canopy Cover
 Used to cover an outlet box when using a live end.

Last updated 06/10/2009.

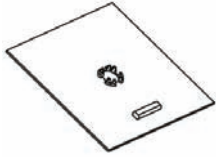

SG 16
Multiple Feed Canopy Cover
 Used to cover an outlet box when using multiple feeds.

Pendant Mount (Add suffix *B-Black, W-White, S-Silver.*)

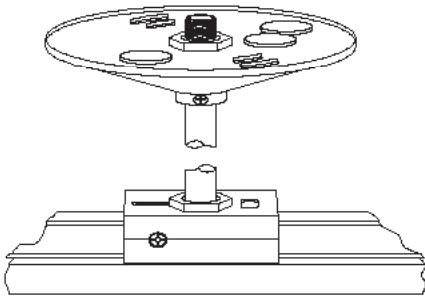

SGM2
2" Pendant Clip

For pendant mounting with aircraft cables or 3/8" stem. Can be used for electrical connection to the track.



SGM4
4" Pendant Clip

For joints of pendant mounted tracks, suspended with aircraft cables or 3/8" stem. Can be used for electrical connection to the track.

3/8" Stem and canopy kit for mechanical and electrical suspension. Does not include mounting hardware to attach stem to track - order separately. Custom lengths available.



SGM8
8" Pendant Clip

For positioning over end feed, for aircraft cable or 3/8" stem mounting. Can be used for electrical connection to the track.

Length Model #

- 12 in. SPUS 12
- 18 in. SPUS 18
- 24 in. SPUS 24
- 36 in. SPUS 36
- 48 in. SPUS 48

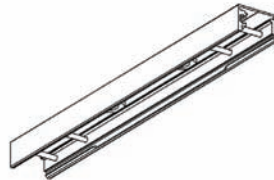

SGM12
12" Pendant Clip

For cable positioning over X, I, L or T connectors for aircraft cable or 3/8" stem mounting. Can be used for electrical connection to the track.

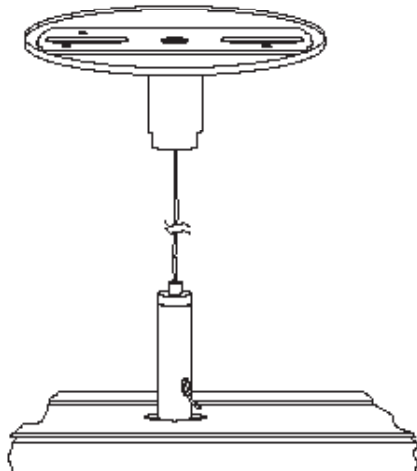

3120
Caddy Clip

Caddy Clip for t-bar systems. Includes nut for clip.

Cable Mount (Add suffix *B-Black, W-White*)

Cable kit with canopy. Custom lengths available.

Length Model #

- 24 in. CG 24
- 48 in. CG 48
- 72 in. CG 72