



# AXT13 13W

1300 Lumen LED



5 Holt Drive,  
Stony Point, NY 10980  
845-947-3034  
info@tslight.com

The AXT13 is designed around the Xicato™ LED remote phosphor module. This module produces an even field of illumination for the most demanding applications. The AXT13 is ideal for museum and retail lighting where a low wattage, high output LED fixture would be required. Xicato™ LEDs exceed ANSI specifications by maintaining tight color consistency over the life of the LED module.

The AXT13 is available in standard black, white, or silver finishes. Custom colors are available upon request.

Manufactured in the USA - IBEW



## XICATO

### Construction

- Aluminum housing with black, white or silver finish
- 0-180° tilt, 360° rotation
- Accepts up to 3 accessories
- Weight: 3 lbs.

### Electrical

- Integral electronic driver
- 100-277V, 50/60Hz
- Meets FCC 47 CFR Part 15/18 Requirements

### Optics

- 20°, 40°, and 60° Field-changable reflectors
- CBCP: 4950 @ 20°  
2750 @ 40°  
1495 @ 60°

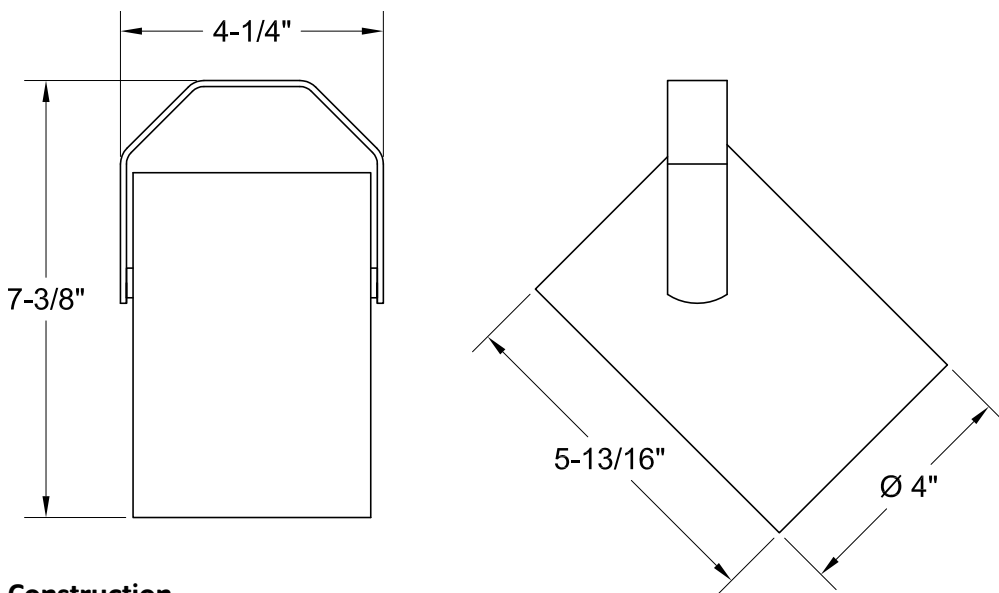

### Construction

- Xicato™ cold remote phosphor LED module
- Color temp options: 2700K, 3000K, 3500K, 4000K
- CRI: 83 standard or 98 optional (R9=96)
- Lumen maintenance: 86% of initial lumen output at 50,000 hours on LM-80 testing
- SDGM: 1 x 2 MacAdam Ellipse. 50 kelvin tolerance
- No UV or IR

Module	Total Wattage	Delivered Lumen	Efficacy (Lm/W)	CRI
83	13	1235	95	83
98	17	1235	67	98

\* Total wattage equals LED plus driver. Delivered lumen may vary depending on LED module, color temperature, optics, and accessories.

### Dimming

- Trailing edge (ELV): 120V only
- Leading edge (Triac): 120V only
- 0-10V: 120-277V with surface mounting. For track applications, use E-series 2-circuit with data bus

### Ordering Matrix

Model	LED Module	Color Temp	Finish	Voltage	Optics	Mounting	Dimming*	Accessories
AXT13	83 98	27 = 2700K 30 = 3000K 35 = 3500K 40 = 4000K	B = Black W = White S = Silver CC = Custom Color	100 120 240 277	20 = 20° 40 = 40° 60 = 60° ZO = 15° - 60°	See Mounting Options	TE = Trailing Edge LE = Leading Edge 010 = 0-10V ND = Non-Dimming	See Accessory Options

Maximum ambient temperature: 35°C  
Maximum operating angle: 45° from vertical

\* See "Notes on Dimming" on reverse

Example: AXT13-83-27-B-120-20-T1-LE-BD20

AXT13- \_\_\_\_\_

\* Specification sheets are subject to change without notice.

## Photometric Data 3000° K 83CRI

### 20° Spot Reflector

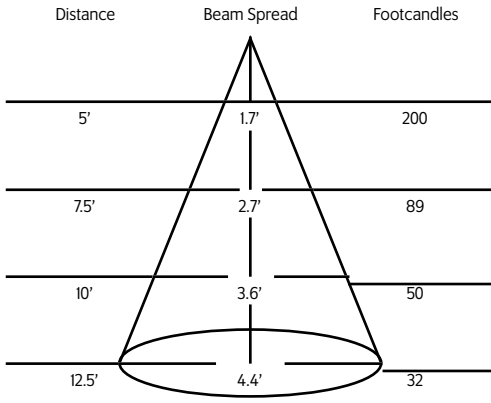

### 40° Medium Flood Reflector

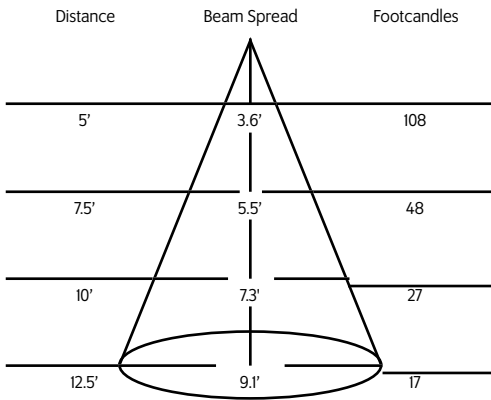

### 60° Flood Reflector

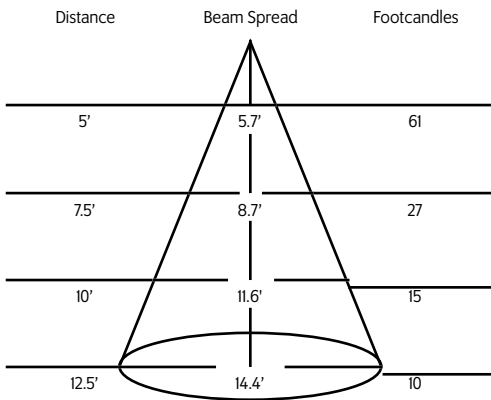

## Mounting Options

**AD1** Track adapter for commercial grade 1 and 2-Circuit track. This adapter is Halo™ and Times Square compatible. 120V.

**DT2** 2-circuit track adapter for SpecTrack databus. 120V.

**HDT2** Track adapter for SpecTrack 2-Circuit data track. 277V.

**TI** Track Adapter for commercial grade 1 & 2 circuit track. 120V. For use with larger, heavier fixtures.

**TA2** Track adapter for G-Series specification grade 2-circuit track. 120V.

**HTA2** Track adapter for G-Series specification grade 2-circuit track. 277V.

**TA3** Track adapter for G-Series specification grade 3-circuit track. 120V.

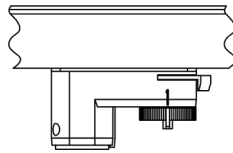

**CM4** Canopy Mount

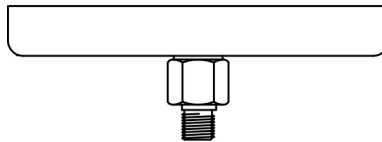

**US1** 6<sup>5</sup>/<sub>8</sub>" x 1<sup>1</sup>/<sub>2</sub>" Unistrut Adapter

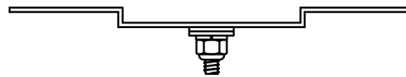

**TB8** 8" x 8" Portable table base for floor and table use



**MC** Light duty pipe clamp for small fixtures. For pipes up to 1 5/16" O.D.

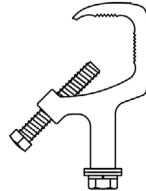

**MN** Medium duty pipe clamp for small to large fixtures. For pipes up to 2" O.D.

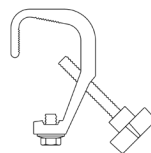

**PC9M** Heavy duty pipe clamp for large, heavy fixtures. For pipes up to 2" O.D.

## Accessories

<b>BD20</b>	Barndoor
<b>LV22</b>	Full Size Louver
<b>XL22</b>	Full Size X Baffle Louver
<b>XH22</b>	Full Size X Baffle Hood
<b>HD22</b>	Hood/Snoot
<b>X00517</b>	Accessory Holder
<b>LV18*</b>	Honeycomb Louver
<b>FX22-26</b>	Red Filter
<b>FX22-80</b>	Blue Filter
<b>FX22-64</b>	Light Blue Filter
<b>FX22-90</b>	Green Filter
<b>FX22-21</b>	Amber Filter
<b>FX22-10</b>	Yellow Filter
<b>FX22-33</b>	Pink Filter
<b>DF22*</b>	Glass Color Filter
<b>OF22-9101*</b>	Smoothing Frost Filter
<b>CC18</b>	Coil Cord Option
<b>SC024</b>	Safety Cable

\* X00517 Required

\* Wide range of colors available.

## Extension Wands

<b>SP 12</b>	12" Stem
<b>SP 18</b>	18" Stem
<b>SP 24</b>	24" Stem
<b>SP X</b>	Custom Length

\* For notes on dimming, please [click here](#).