



CT60

RGBW + Tunable White



5 Holt Drive
Stony Point, NY 10980
845-947-3034
www.tslight.com

The CT60 features tunable color and a high CRI output. It can be controlled via DMX/RDM, Lutron Ecosystem, Bluetooth, or even 010V controls. The CT60 features tunable white from 1650K-8000K with a CRI of 90+ across the entire temperature range. Rich blues, ambers, reds, violets and greens can be added in gradients or can completely saturate the output of the light. Interchangeable reflectors allow beam angles between 12° and 64°. This fixture is perfect for churches, events, or use in an archtainment setting. It's also a good option for retail, due to it's powerful output and high CRI values.

Manufactured in the USA - IBEW



Construction

- Steel & aluminum housing with black, white or silver finish
- 0-90° tilt, 360° rotation
- Internal multiple accessory holder
- Weight: 7 lbs.

Electrical

- Integral electronic driver
- 100-277V, 50/60Hz
- Meets FCC 47 CFR Part 15/18 Requirements
- RJ45 comes standard XLR 3-Pin and 5-Pin adapters are available.
- Consult factory when ordering canopy mount option to configure data connections.
- Can be track mounted with STA adapter and controlled with DMX or 010V protocol.
- DMX Addressing is RDM-only (No onboard DMX).

Optics

- 12°, 19°, 33° 40°, 48°, 55°, and 64°
Field - changeable reflectors

Emitter 2-Year Warranty

The warranty on the LED Emitter used in this Times Square Lighting product shall have a two year warranty from the date of purchase.

*Specification sheets are subject to change without notice.

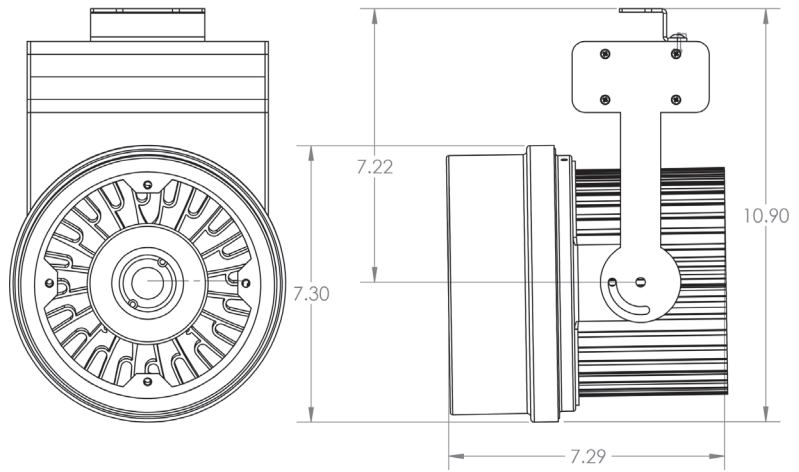

Features

- Bluetooth commissioning tool for setting DMX address from your phone or tablet.
- Four channel DMX mode: Dim, variable white, saturation, hue.
- Dims to below 1% of initial output
- Variable white between 1650 and 8000 kelvin. Can be controlled by 010V controller or DMX controller.

LED

- RGBW + Tunable White
- CRI: 90+ CRI
- Beam Angle: 12°, 19°, 33° 40°, 48°, 55°, 64°
- Variable white: 1650 - 8000K
- No UV or IR

| CRI | Total Wattage | Lumens | Efficacy (Lm/W) |
|-----|---------------|--------|-----------------|
| 90+ | 60 | 5000 | 83 |

*Total wattage equals LED plus driver. Delivered lumen may vary depending on LED module, color temperature, optics, and accessories.

Ordering Matrix

| Model | Finish | Voltage | Optics | Mounting | Dimming* |
|-------|---|------------|--|----------------------------|-------------|
| CT60 | B = Black W = White S = Silver CC = Custom Color | 120 277 | 10=10° 12=12° 19=19° 33=33° 40=40° 54=54° 64=64° | See Mounting Options | DX= DMX/RDM |

Maximum ambient temperature: 35°C
Maximum operating angle: 45° from vertical

* See "Notes on Dimming" on reverse

Example: CT60-9230-B-120-CM4-010

CT60- _____ - _____ - _____ - _____ - _____

Photometric Data 3000° K 92 CRI

12° Spot Reflector

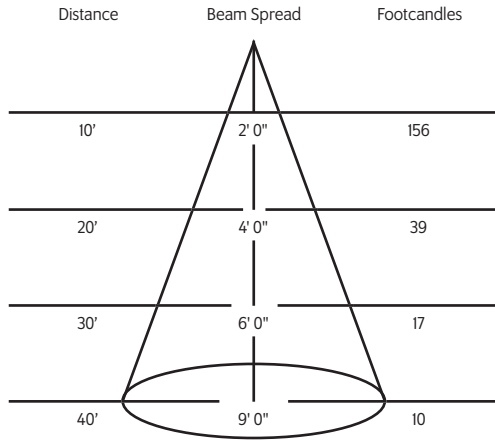

40° Spot Reflector

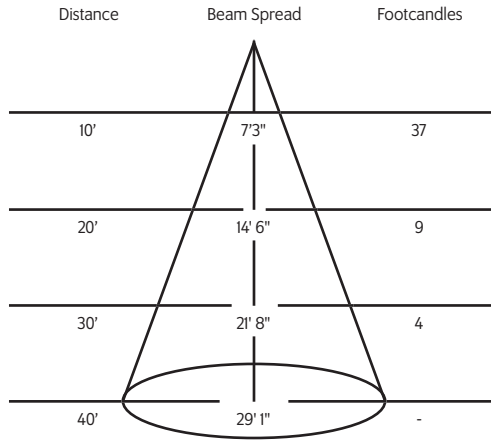

55° Medium Flood Reflector

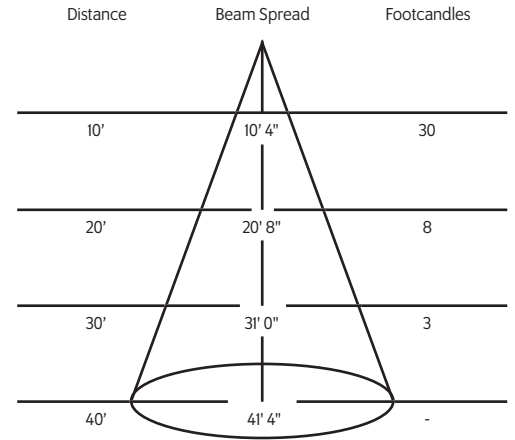

19° Medium Flood Reflector

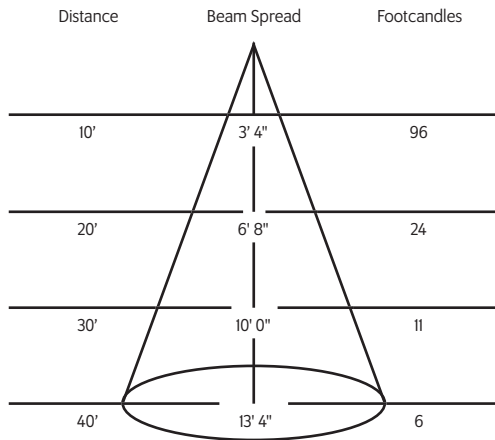

48° Medium Flood Reflector

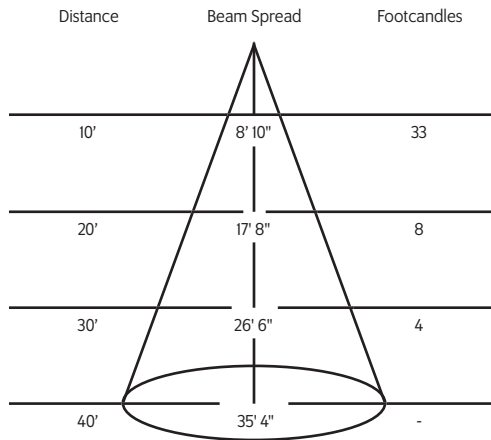

33° Flood Reflector

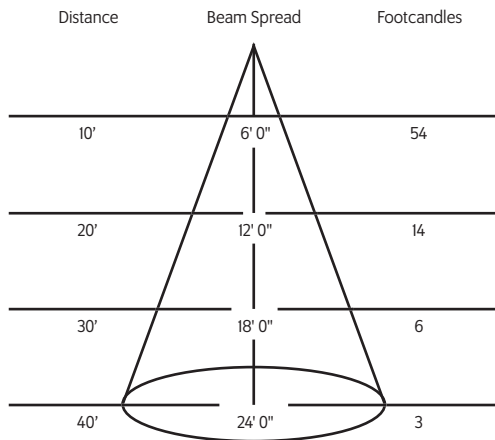

64° Flood Reflector

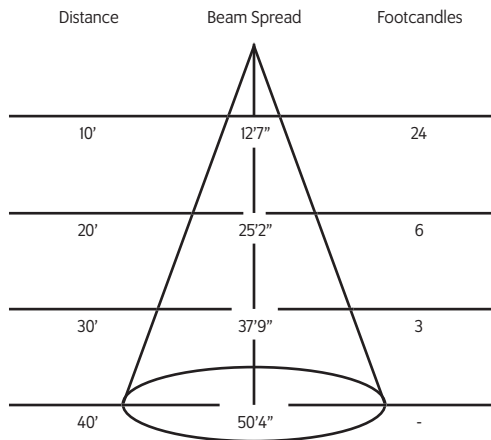

Mounting Options

DT2 2-circuit track adapter for SpecTrack databus. 120V.

HDT2 Track adapter for SpecTrack 2-Circuit data track. 277V.

GAC Track adapter for 120V global pulse track.

CM4* Canopy mount (Bluetooth, 010V dimming only)

US1 6 $\frac{5}{8}$ " x 1 $\frac{1}{2}$ " Unitrut Adapter

TB8 8" x 8" Portable table base for floor and table use

MN Medium duty pipe clamp for small to large fixtures. For pipes up to 2" O.D.

PC9M Heavy duty pipe clamp for large, heavy fixtures. For pipes up to 2" O.D.

* Contact factory for wiring details.

Color Tuning Features

- Color gamut control: gradients of saturated colors from 1 - 100% can be added to color points
- 90+ CRI
- Dimmable from 100 - 1% at constant CCT
- DMX512-A-RDM or Lutron EcoSystem compatible
- DMX controls dimming, hue, saturation and tunable white
- Available with RJ45 or XLR sockets
- On-board Bluetooth Low Energy (BLE)
- Tunable range: 1650 - 8000K
- SceneSet enables up to five scenes to be preprogrammed and recalled using a 0 - 10V recommended dimmer or via Bluetooth
- Addressing and integration by RDM or via wireless araya5 Tunable Color iOS app
- 0-10V, DMX512-A-RDM2, Bluetooth Low Energy, Lutron® EcoSystem® are all available as control options. Must be specified and ordered to pair with desired control system from factory.
- L70 greater than 50,000 hours

Accessories

| | |
|----------------|----------------------------------|
| LV9 | Louwer |
| LV9BD | Louwer (for use with BD9) |
| BD9 | Barndoor |
| HD9 | Hood |
| XH9 | Cross Baffle Hood |
| CF9 | Color Frame |
| GF9 | Glass Color Filter |
| DF9 | Dichroic Color Filter |
| GF9-600 | 5°x50° Linear Lens |
| GF9-601 | Beam Softener |
| GF9-673 | 50°x50° Spread Lens |
| CC18 | Coiled Cord |
| SC-24 | Safety Cable |
| W6538 | RJ45 to female 5-Pin XLR Adapter |

Extension Wands

| | |
|--------------|--------------------------------|
| SP 12 | 12" Stem |
| SP 18 | 18" Stem |
| SP 24 | 24" Stem |
| SP X | Custom Length |
| W6539 | RJ45 to male 5-Pin XLR adapter |