



Manufactured in the USA - IBEW



Construction

- Steel & aluminum housing with black, white or silver finish
- Internal multiple accessory holder
- Weight: 7 lbs.

Electrical

- Integral electronic driver
- 100-277V, 50/60Hz
- Meets FCC 47 CFR Part 15/18 Requirements

Optics

- 12°, 19°, 33° 40°, 48°, 55°, and 64°
Field - changeable reflectors

CR80

65W, 7500 Lumen LED



5 Holt Drive,
Stony Point, NY 10980
845-947-3034
info@tslight.com

The CR80 is a powerful LED fixture designed for medium to long throw applications. This efficient, 65-watt LED fixture can produce a 12° degree beam that rivals line voltage PAR technology. The CR80 utilizes a Cree XLamp LED array that delivers a high lumen output and uniform color. At full 7400 lumen output, the fixture can be dimmed on any 0-10v dimming package. A trailing edge (ELV) and leading edge (triac) dimmer system will yield 7000 lumens maximum.

The CR80 is available in Black, White, and Silver finishes. Custom colors are available upon request.

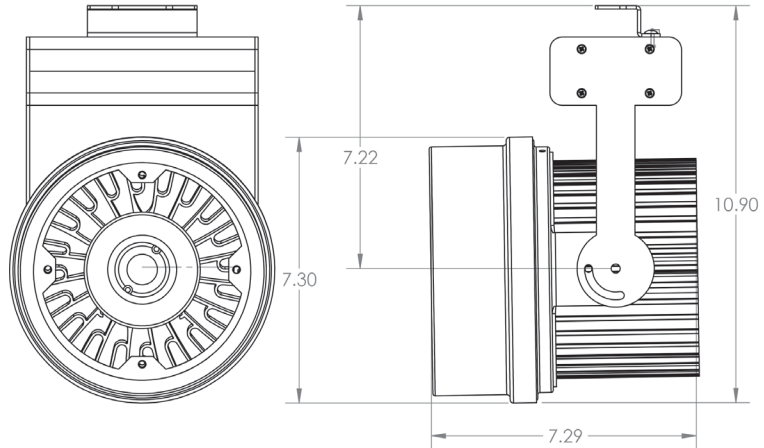

LED

- 2700K, 3000K, 3500K, 4000K, 5000K
- CRI: 80 Standard or 92 Optional
- Beam Angle: 12°, 19°, 33° 40°, 48°, 55°, 64°
- Cree XLamp LED array
- No UV or IR

CRI	Total Wattage	Delivered Lumen	Efficacy (Lm/W)	CRI
80	65	7400	123	80

* Total wattage equals LED plus driver. Delivered lumen may vary depending on LED module, color temperature, optics, and accessories.

* Testing done with 4000K COB.

Dimming

- Trailing edge (ELV): 120V (7000 max lumens)
- Leading edge (Triac): 120V (7000 max lumens)
- 0-10V: 120-277V with surface mounting. For track applications, use E-series 2-circuit with data bus.
- **Lutron Consult Factory for Details**
- See ICR80 specification sheet for DMX Dimming (LINK).

Ordering Matrix

Model	LED Module	Color Temp	Finish	Voltage	Optics	Mounting	Dimming*	Accessories
CR80	80 92	27=2700K	B = Black	120	12=12°	See Mounting Options	TE = Trailing Edge† LE = Leading Edge† 010 = 0-10V ND = Non-Dimming	See Accessory Options
		30=3000K	W = White	240	19=19°			
		35=3500K	S = Silver	277	33=33°			
		40=4000K	CC = Custom		40=40°			
		50=5000K	Color		48=48°			
		57=5700K			55=55° 64=64°			

Maximum ambient temperature: 35°C † 120V Only
Maximum operating angle: 45° from vertical

* See "Notes on Dimming" on reverse

Example: CR80-9230-B-120-CM4-010

CR80- _____ - _____ - _____ - _____ - _____

* Specification sheets are subject to change without notice.

Mounting Options

DT2 2-Circuit track adapter for SpecTrack Databus. 120V.

TA2 Track adapter for G-Series specification grade 2-circuit track. 120V.

HTA2 Track adapter for G-Series specification grade 2-circuit track. 277V.

STA 2 circuit track adapter for Data Bus. Specification grade track. 120V.

HSTA 2 circuit track adapter for Data Bus. Specification grade track. 277V.

TA3 Track adapter for G-Series specification grade 3-circuit track. 120V.

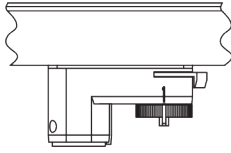

CM4 Canopy Mount

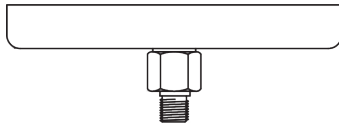

US1 6 $\frac{3}{8}$ " x 1 $\frac{1}{2}$ " Unistrut Adapter

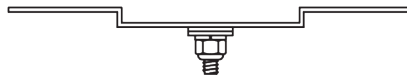

TB8 8" x 8" Portable table base for floor and table use



MN Medium duty pipe clamp for small to large fixtures. For pipes up to 2" O.D.

PC9M Heavy duty pipe clamp for large, heavy fixtures. For pipes up to 2" O.D.

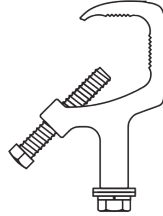

Accessories

LV9	Louver
LV9BD	Louver (for use with BD9)
BD9	Barndoor
HD9	Hood
SH9	Sparkle Hood
XH9	Cross Baffle Hood
CF9	Color Frame
GF9	Glass Color Filter
DF9	Dichroic Color Filter
GF9-600	5°x50° Linear Lens
GF9-601	Beam Softener
GF9-673	50°x50° Spread Lens
CC18	Coiled Cord
SC-24	Safety Cable

Extension Wands

SP 12	12" Stem
SP 18	18" Stem
SP 24	24" Stem
SP X	Custom Length

Notes on Dimming:

- **TE** This means the fixture will work on *MOST* quality Trailing Edge dimmers. These dimmer types are also known as Reverse Phase or Electronic Low Voltage (ELV), and are available as wall mount and rack mount modules.
- **LE** This means the fixture will work on *MOST* quality Leading Edge dimmers. These dimmer types are also known as Forward Phase, Incandescent, Halogen or Triac, and are available as wall mount and rack mount modules.
- **0-10** This means the fixture will work on *MOST* quality 0-10V or 1-10V dimmers. These dimmer types are also known as Fluorescent, and are available as wall mount and rack mount modules.
- **IP** This means the fixture has a dimmer *BUILT IN* to the fixture itself, and will dim to about 50%. It has an integral potentiometer located on the bottom of the driver housing. This fixture *WILL NOT* function with *EXTERNAL* wall or rack dimmers.
- **DX** This means fixture complies with ESTA DMX512 -A Standards.

It is impractical to test every fixture type with every dimmer type, and some combinations work better than others, while some not at all.

It is advisable to pretest a particular fixture with an intended dimmer beforehand to insure that the combination will work as expected.

Some dimmers will allow for full-range dimming, while others will only dim to 50%.

Some dimmers will work well within a certain range, and perhaps flicker or shut off at the lowest settings, rendering that portion of the range unusable.

Most if not all dimmers have a maximum LED load that can be applied, often as little as 10% of its nominally rated value.

Dimming LEDs can actually extend their life expectancy, and will not affect the color temperature or CRI.

Photometric Data

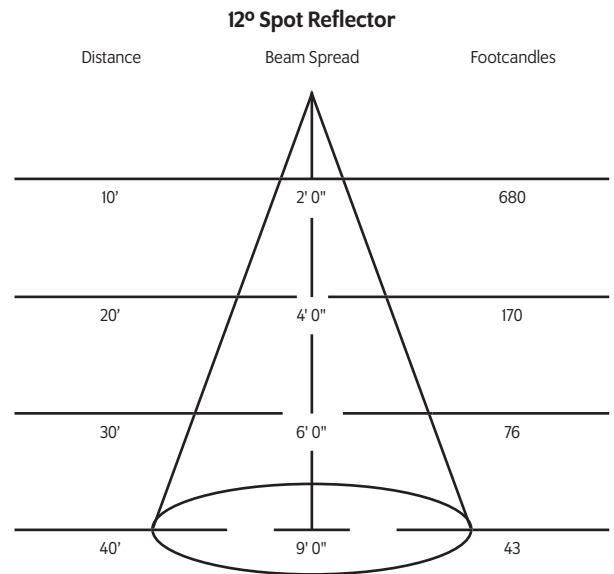

Photometric Data Continued...

19° Spot Reflector

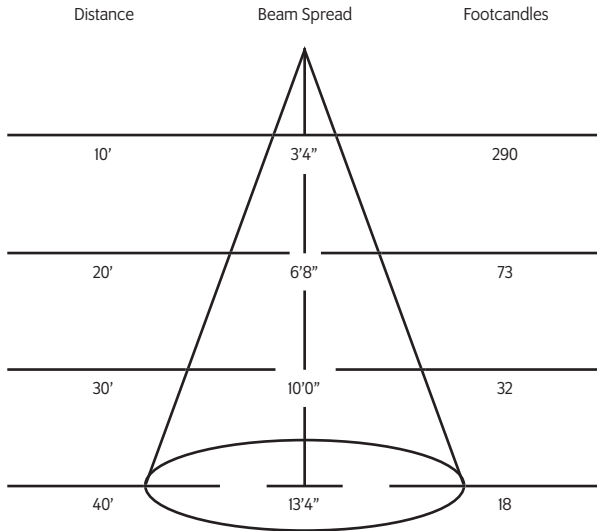

33° Spot Reflector

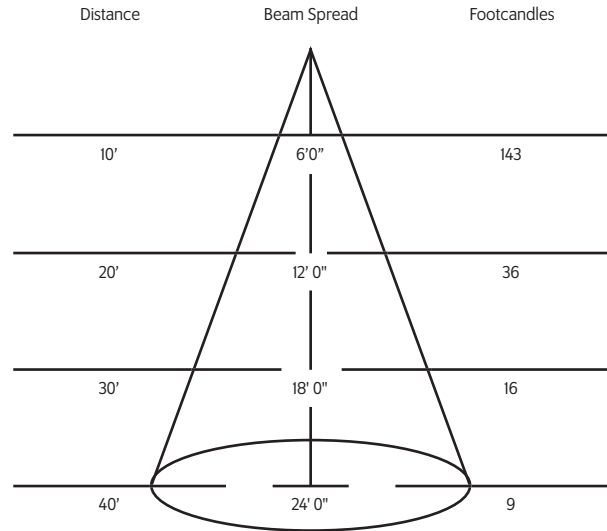

40° Spot Reflector

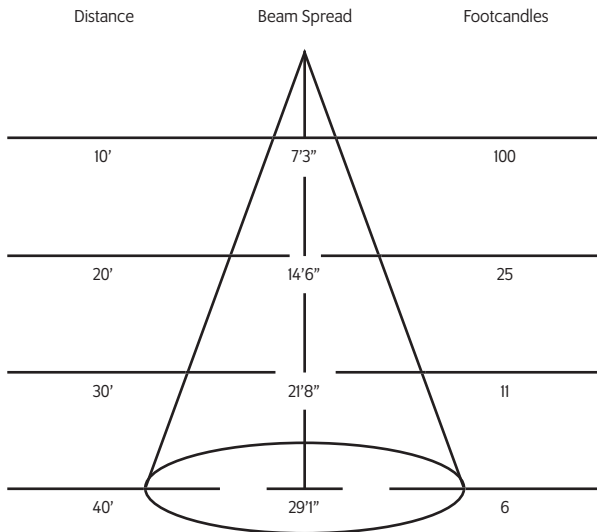

48° Spot Reflector

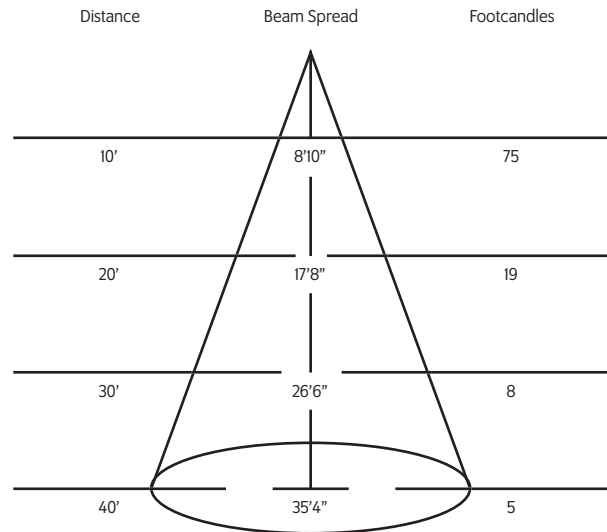

55° Spot Reflector

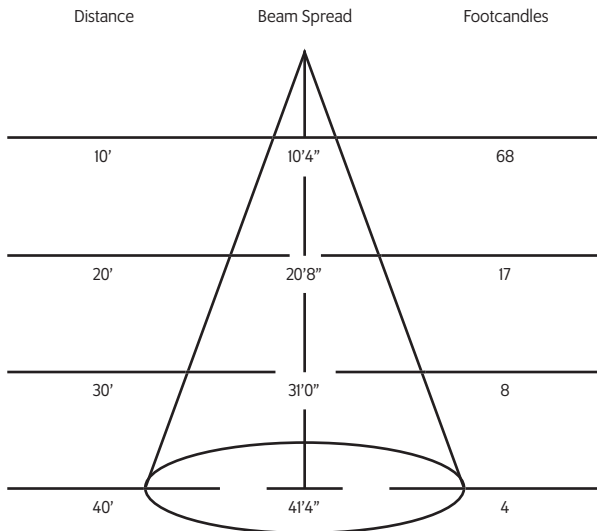

64° Spot Reflector

