



Manufactured in the USA - IBEW



XICATO

Construction

- Steel & aluminum housing with black, white or silver finish
- 0-180° tilt, 360° rotation
- Accepts up to 3 accessories
- Weight: 3 lbs.

Electrical

- Integral electronic driver
- 100-277V, 50/60Hz
- Meets FCC 47 CFR Part 15/18 Requirements

Optics

- 20°, 40°, and 60° Field-changeable reflectors
- CBCP: 2750 @ 20°
1450 @ 40°
800 @ 60°

AXT7 6.5W

720 Lumen LED



5 Holt Drive,
Stony Point, NY 10980
845-947-3034
info@tslight.com

The AXT7 is designed around the Xicato™ LED remote phosphor module. This module produces an even field of illumination for the most demanding applications. The AXT7 is ideal for museum and retail lighting where a low wattage, high output LED fixture would be required. Xicato™ LEDs exceed ANSI specifications by maintaining tight color consistency over the life of the LED module.

The AXT7 is available in standard black, white, or silver finishes. Custom colors are available upon request.

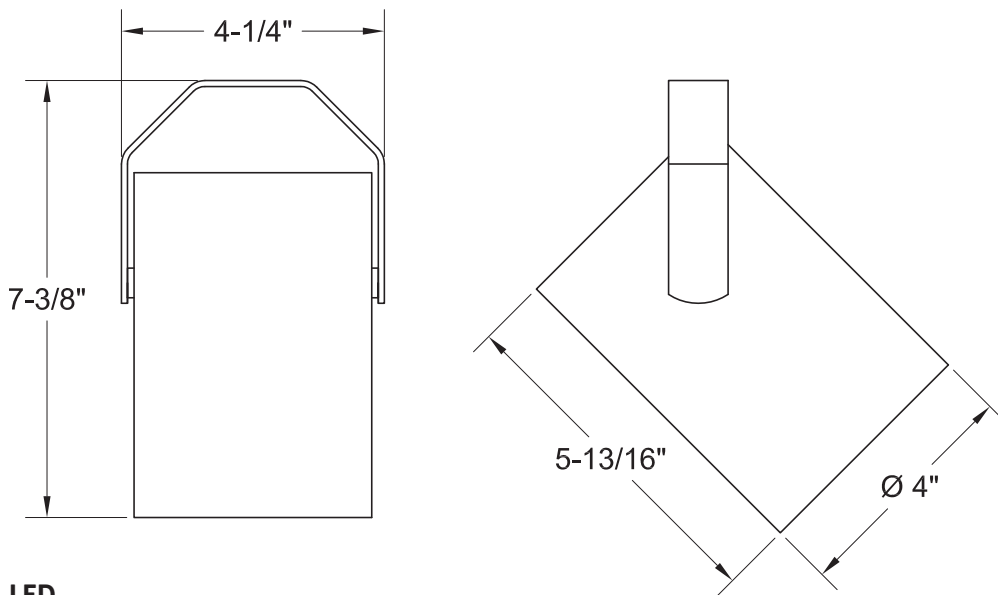

LED

- Xicato™ cold remote phosphor LED module
- Color temp options: 2700K, 3000K, 3500K, 4000K
- CRI: 83 standard or 98 optional (R9=96)
- Lumen maintenance: 86% of initial lumen output at 50,000 hours on LM-80 testing
- SDGM: 1 x 2 MacAdam Ellipse. 50 kelvin tolerance
- No UV or IR

Module	Total Wattage	Delivered Lumen	Efficacy (Lm/W)	CRI
83	6.5	684	95	83
98	8.5	684	67	98

* Total wattage equals LED plus driver. Delivered lumen may vary depending on LED module, color temperature, optics, and accessories.

Dimming

- Trailing edge (ELV): 120V only
- Leading edge (Triac): 120V only
- 0-10V: 120-277V with surface mounting. For track applications, use E-series 2-circuit with data bus

Ordering Matrix

Model	LED Module	Color Temp	Finish	Voltage	Optics	Mounting	Dimming*	Accessories
AXT7	83 98	27 = 2700K 30 = 3000K 35 = 3500K 40 = 4000K	B = Black W = White S = Silver CC = Custom Color	100 120 240 277	20 = 20° 40 = 40° 60 = 60° ZO = 15° - 60°	See Mounting Options	TE = Trailing Edge LE = Leading Edge 010 = 0-10V ND = Non-Dimming	See Accessory Options

Maximum ambient temperature: 35°C
Maximum operating angle: 45° from vertical

* See "Notes on Dimming" on reverse

Example: AXT7-83-27-B-120-20-T1-LE-BD20

AXT7- _____ - _____ - _____ - _____ - _____ - _____ - _____

* Specification sheets are subject to change without notice.

Photometric Data 3000° K 83CRI

20° Spot Reflector

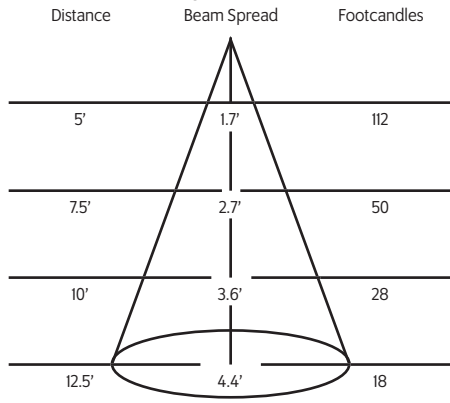

40° Medium Flood Reflector

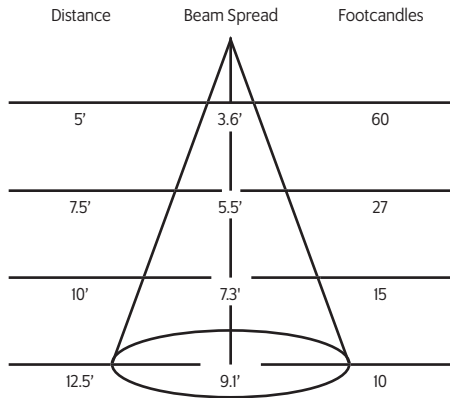

60° Flood Reflector

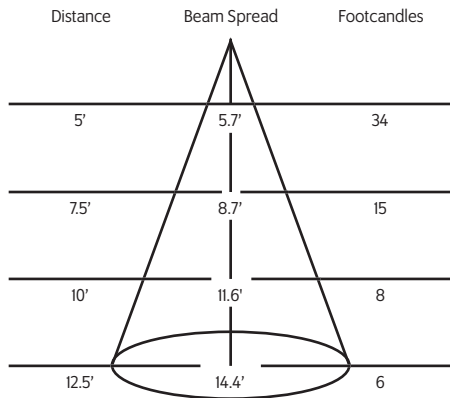

Mounting Options

TI Track Adapter for commercial grade 1 & 2 circuit track. 120V. For use with larger, heavier fixtures.

TAI Track adapter for E-Series specification grade track. 1 circuit. 120V.

TA2 Track adapter for G-Series specification grade 2-circuit track. 120V.

HTA2 Track adapter for G-Series specification grade 2-circuit track. 277V.

STA 2 circuit track adapter for Data Bus. Specification grade track. 120V.

TA3 Track adapter for G-Series specification grade 3-circuit track. 120V.

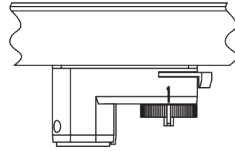

CM4 Canopy Mount

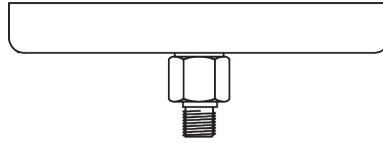

US1 6⁵/₈" x 1¹/₂" Unistrut Adapter



TB8 8" x 8" Portable table base for floor and table use



MC Light duty pipe clamp for small fixtures. For pipes up to 15/16" O.D.

MN Medium duty pipe clamp for small to large fixtures. For pipes up to 2" O.D.

PC9M Heavy duty pipe clamp for large, heavy fixtures. For pipes up to 2" O.D.

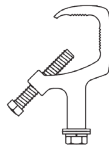

Accessories

BD20

Barndoor

LV22

Full Size Louver

XL22

Full Size X Baffle Louver

XH22

Full Size X Baffle Hood

HD22

Hood/Snoot

X00517

Accessory Holder

LV18*

Honeycomb Louver

DF22*

Glass Color Filter

OF22-9101*

Smoothing Frost Filter

GF22-600*

5x50 Linear Lens

GF22-601*

Solite Softner

GF22-673*

50 x 50 Spread Lens

CC18

Coil Cord Option

SC024

Safety Cable

* X00517 Required

Extension Wands

SP 12

12" Stem

SP 18

18" Stem

SP 24

24" Stem

SP X

Custom Length

Notes on Dimming:

- TE** This means the fixture will work on *MOST* quality Trailing Edge dimmers. These dimmer types are also known as Reverse Phase or Electronic Low Voltage (ELV), and are available as wall mount and rack mount modules.
- LE** This means the fixture will work on *MOST* quality Leading Edge dimmers. These dimmer types are also known as Forward Phase, Incandescent, Halogen or Triac, and are available as wall mount and rack mount modules.
- 0-10** This means the fixture will work on *MOST* quality 0-10V or I-10V dimmers. These dimmer types are also known as Fluorescent, and are available as wall mount and rack mount modules.
- IP** This means the fixture has a dimmer *BUILT IN* to the fixture itself, and will dim to about 50%. It has an integral potentiometer located on the bottom of the driver housing. This fixture *WILL NOT* function with *EXTERNAL* wall or rack dimmers.

It is impractical to test every fixture type with every dimmer type, and some combinations work better than others, while some not at all. It is advisable to pretest a particular fixture with an intended dimmer beforehand to insure that the combination will work as expected. Some dimmers will allow for full-range dimming, while others will only dim to 50%. Some dimmers will work well within a certain range, and perhaps flicker or shut off at the lowest settings, rendering that portion of the range unusable. Most if not all dimmers have a maximum LED load that can be applied, often as little as 10% of its nominally rated value. Dimming LEDs can actually extend their life expectancy, and will not affect the color temperature or CRI.