

Times Square Lighting's 7-conductor (2 live / 2 neutral / 1 ground / 2 data) 2-Circuit Track with Data Bus offers the ability to control fixtures with DMX, 010V or DALI protocol. The data can be accessed anywhere along the track. Other fixtures with standard (non data bus) E-Series 2-circuit track adapters can be energized by this track system.

E-Series

Specification Grade 2-Circuit 277 Volt Track with Data Bus



5 Holt Drive,
Stony Point, NY 10980
845-947-3034
info@tslight.com

Track Section

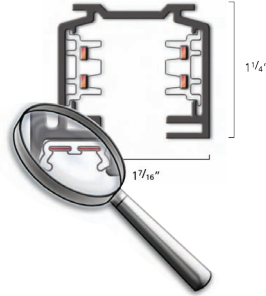

4 ft. HST4-*
8 ft. HST8-*
12 ft. HST12-*

Add suffix B-Black, W-White, S-Silver.
Custom lengths available. Please consult factory.

COMPONENTS *(Add suffix B-Black, W-White, S=Silver)*

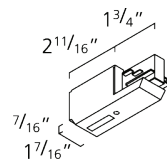

HST11-* (ground contact right)
HST13-* (ground contact left)
Live End Feed
Used when energizing track from an outlet box or conduit feed.

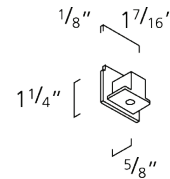

TS-900-*
End Caps
Used to end any open configuration of track.

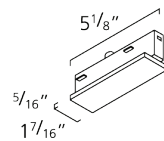

HST10-*
Floating Mid Feed
Can be positioned anywhere along the track.

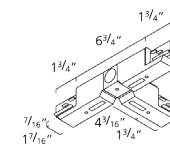

HST39-* (ground contact right)
HST40-* (ground contact left)
T Connector Feed
Used to join three sections of track in a "T" configuration. May be used as a feed point.

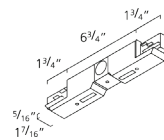

HST14-*
Center Feed
Used to join two sections of track together in a straight line. May be used as a feed point.

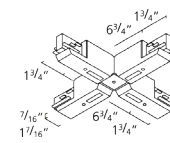

HST38-*
X Connector Feed
Used to join four sections of track together in an "X" configuration. May be used as a feed point.

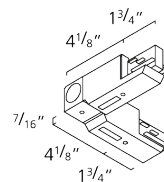

HST34-* (ground contact right)
HST35-* (ground contact left)
L Connector Feed
Used to join two sections of track together at a 90° angle. May be used as a feed point.

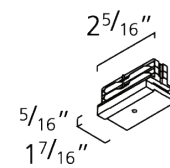

HST21-*
Straight Connector
Used to join two sections of track together in a straight line.

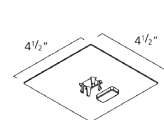

ST15-*
Multiple Feed Canopy Cover
Used to cover an outlet box when using Center, Flex, X Connector, or L Connector feeds.

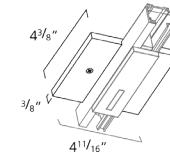

ST16-*
Mid Feed Canopy Cover
Used to cover an outlet box when using Floating Mid Feed.

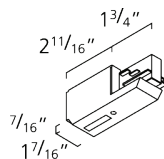

HST11 TERM-* (ground contact right)
HST13 TERM-* (ground contact left)
Live End Feed
Used when energizing track from an outlet box or conduit feed.

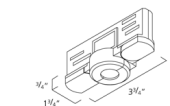

99-571 TERM
Retrofit Terminating Resistor
Used to terminate DMX configuration.

PENDANT MOUNT (Add suffix B-Black, W-White, S=Silver)

3/8" Stem and canopy kit for mechanical and electrical suspension. Does not include mounting hardware to attach stem to track - order separately. Custom lengths available.

Length	Model #
12 in.	SPUS 12
18 in.	SPUS 18
24 in.	SPUS 24
36 in.	SPUS 36
48 in.	SPUS 48

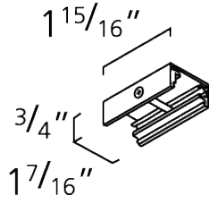
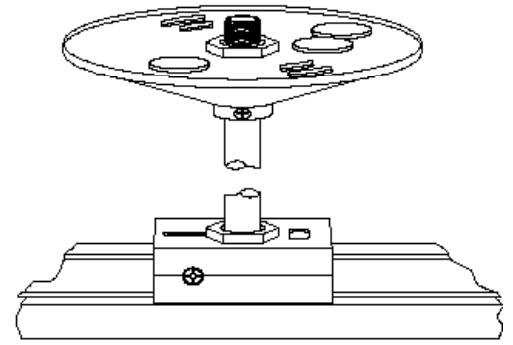

SGM2 2" Pendant Clip

For pendant mounting with aircraft cables or 3/8" stem.

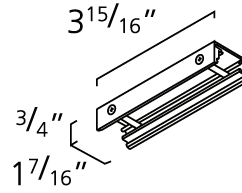

SGM4 4" Pendant Clip

For joints of pendant mounted tracks, suspended with aircraft cables or 3/8" stem.

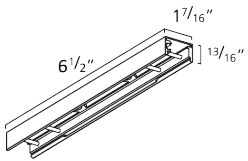

SGM6 6" Pendant Clip

For positioning over end feed. For aircraft cable or 3/8" stem mounting. Can be used for electrical connection to the track.

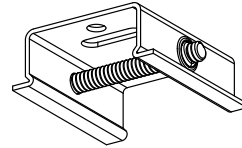

SKBX-12 Ceiling Clamp All Tiles Recessed T Grid Clip