



# MR16 Cube

Soraa LED



5 Holt Drive,  
Stony Point, NY 10980  
845-947-3034  
info@tslight.com

The MR16 cube light is a low voltage fixture ideal for highlighting artwork, exhibits, and retail displays. The unit accepts energy efficient MR16 lamps from 20 to 75-watts. These lamps come in a variety of beam spreads, which are interchangeable as needed. They offer excellent color rendering and produce a whiter, brighter light than standard incandescent lamps.

The MR16 cube light features an electronic transformer and locking yoke with brake. Its external accessory holder accepts louvers, barndoors, hoods and filters. Comes in standard black, white and silver finishes. Custom colors are available by request and at an additional charge.

Manufactured in the USA - IBEW



## Features

- 120, 220 and 277-volt available
- Integral 12-volt dimmable transformer
- Accepts energy efficient MR16 lamps from 20 to 75-watts
- Numerous mounting options and accessories
- Weight: 2 lbs.

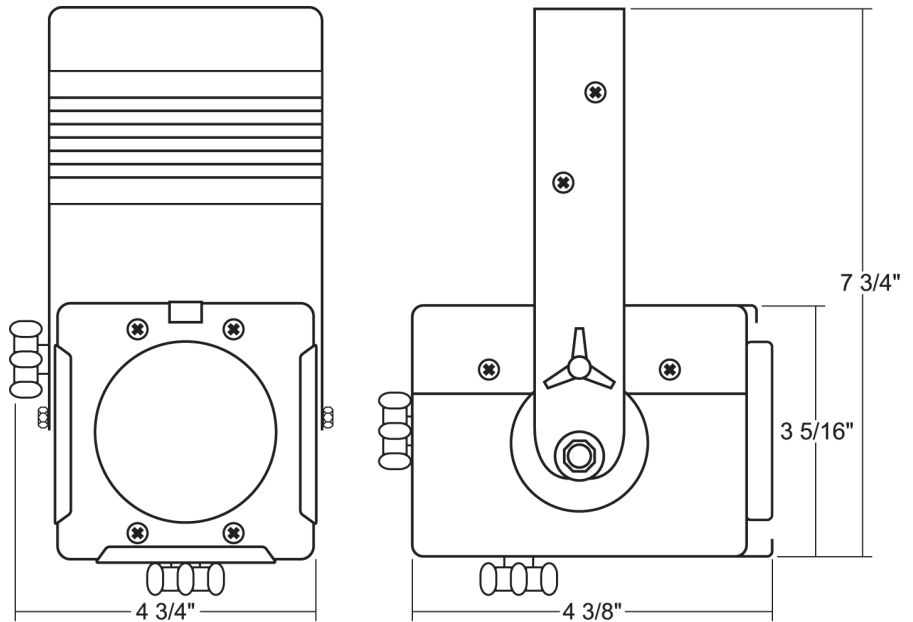

## LED Lamp Types

Lamp Type	Watts	CRI	Lumens*
Vivid	7.5	95	390
Vivid	7.5	95	410
Vivid	7.5	95	430
Brilliant	7.5	90	620
Brilliant	7.5	90	640

## Ordering Matrix

Model	Finish	Mounting	Accessories
MR16	B = Black W = White S = Silver CC = Custom Color	See Mounting Options	See Accessory Options

Example: MR16-B-T1-LV1

MR16-\_\_\_\_\_ - \_\_\_\_\_ - \_\_\_\_\_

\*Specification sheets are subject to change without notice.

## Photometric Data

### 20° Beam, 3000°K

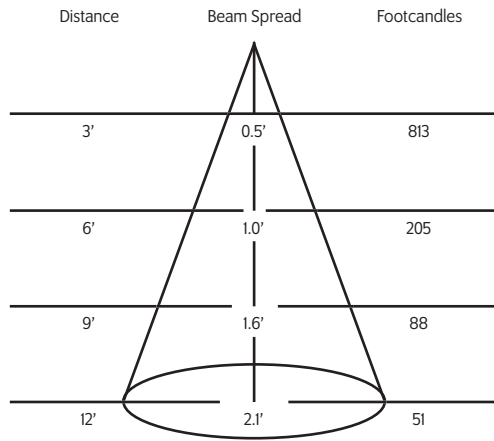

### 25° Beam, 3000°K

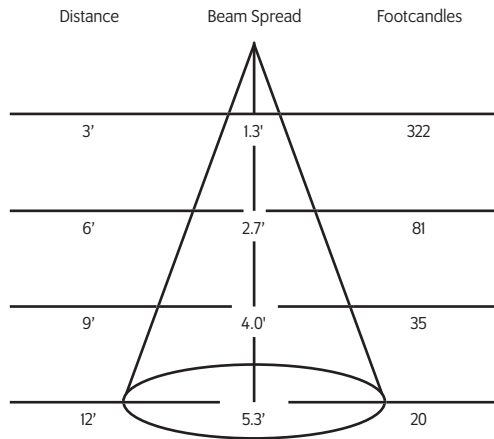

### 36° Beam, 3000°K

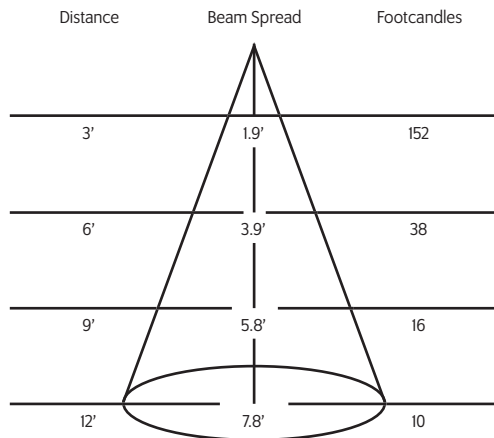

### 60° Beam, 3000°K

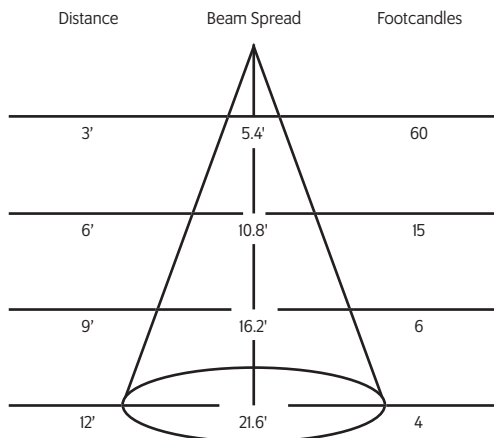

## Mounting Options

**AD1** Track Adapter for commercial grade 1 & 2 circuit track. 120V. For use with lightweight fixtures.

**T1** Track Adapter for commercial grade 1 & 2 circuit track. 120V. For use with larger, heavier fixtures.

**TA2** Track adapter for G-Series specification grade 2-circuit track. 120V.

**HTA2** Track adapter for G-Series specification grade 2-circuit track. 277V.

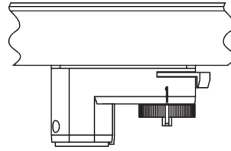

**CM4** Canopy Mount

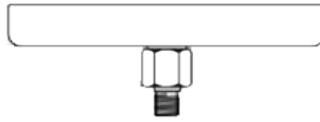

**US1** 6 $\frac{5}{8}$ " x 1 $\frac{1}{2}$ " Unistrut Adapter



**TB4** 6 $\frac{1}{4}$ " Portable wall mount/table base floor, wall or table use.



**MC** Light duty pipe clamp for small fixtures. For pipes up to 1 5/16" O.D.

**MN** Medium duty pipe clamp for small to large fixtures. For pipes up to 2" O.D.

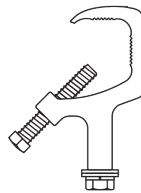

## Accessories

<b>LV4</b>	Louver
<b>XL4</b>	Cross Baffle Louver
<b>BD4</b>	Barndoor
<b>HD4</b>	Hood
<b>XH4</b>	Cross Baffle Hood
<b>CF4</b>	Color Frame
<b>GF4</b>	Glass Color Filter
<b>DF4</b>	Dichroic Color Filter
<b>GF4-600</b>	5°x50° Linear Lens
<b>GF4-601</b>	Beam Softener
<b>GF4-673</b>	50°x50° Spread Lens
<b>CC18</b>	Coiled Cord
<b>SC-24</b>	Safety Cable
<b>IP</b>	Integral Dimmer



## Snap Accessories

<b>01145</b>	25° Beam Spreader Snap
<b>01147</b>	36° Beam Spreader Snap
<b>01149</b>	60° Beam Spreader Snap
<b>01595</b>	10°-36° Linear Snap
<b>03261</b>	10°-60° Linear Snap
<b>01597</b>	36°x36° Flat Top Snap
<b>01151</b>	40° Cutoff Louver
<b>03257</b>	20° Maximum Deflection Snap
<b>01153</b>	1/4 Color Temperature Shift Snap
<b>01155</b>	1/2 Color Temperature Shift Snap
<b>01157</b>	3/4 Color Temperature Shift Snap
<b>03283</b>	Enhance Snap
<b>02185-C</b>	Color Snap (Specify Color)

## Extension Wands

<b>SP 12</b>	12" Stem
<b>SP 18</b>	18" Stem
<b>SP 24</b>	24" Stem
<b>SP X</b>	Custom Length

## Finish

<b>B</b>	Black
<b>W</b>	White
<b>S</b>	Silver
<b>CC</b>	Custom Color