



# GU10

## SORAA LED



5 Holt Drive,  
Stony Point, NY 10980  
845-947-3034  
info@tslight.com

A classic design and favorite, this budget friendly fixture can complement any décor. Features a line voltage Soraa LED lamp with a GU10 base. These LED lamps work with most leading or trailing edge dimmers. Made of an extruded aluminum construction, it is dependable for residential and commercial applications. Numerous mounting options and accessories are available.

By utilizing Soraa's Snap System, there are unlimited possibilities for customizing this fixture. Options include the ability to field change the beam angle (Beam Spreader Snap), alter color temperature (CTO Snap), or to add a louver. Color Snaps can be used to produce brilliant hues of any color that Rosco or Lee offer.

The Enhance Lens Snap can increase the vividness of warm colors (including red, orange and pink and greens). Aim Snaps can bend the beam to a maximum deflection angle of 20°. Linear Snap Lenses can alter the beam to act as a wall wash.

Manufactured in the USA - IBEW



### LED

- Color temp options: 2700K and 3000K
- CRI: 90 or 95
- No UV or IR

### Dimming\*

- Trailing edge (ELV)
- Leading edge (Triac)

\* See "Notes on Dimming" on reverse.

### Construction

- Extruded aluminum housing with black, white or silver finish
- 0-180° tilt, 360° rotation
- Locking yoke
- Accepts accessories
- Weight: 1.5 lbs.

### Electrical

- Electronic driver
- 100-120V, 50/60Hz
- Meets FCC 47 CFR Part 15/18 Requirements

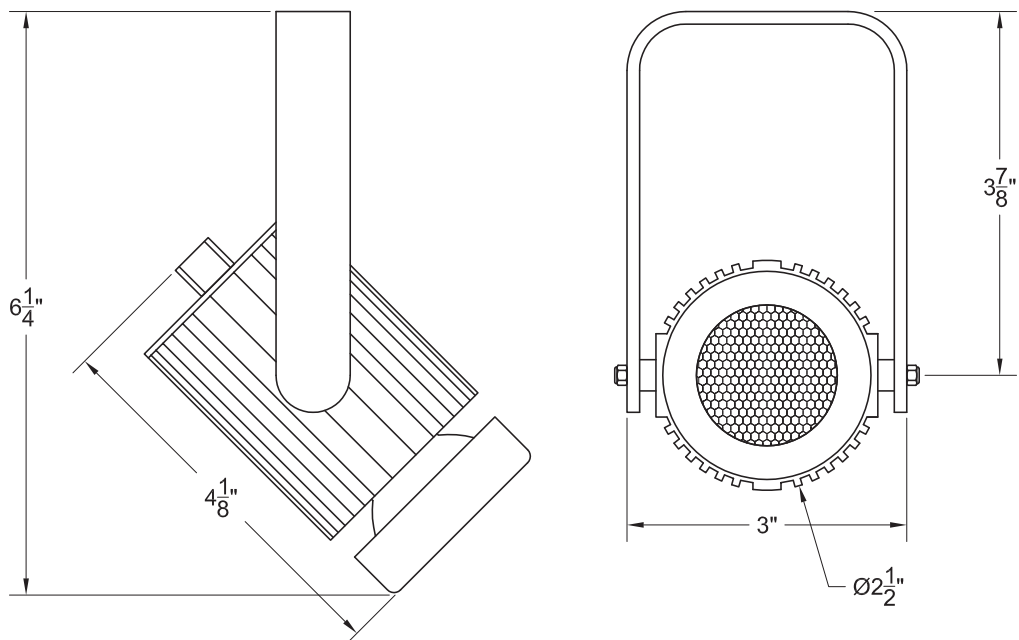

Lamp Type	Watts	CRI	Lumens*
Brilliant	7.5	90 (R9=0)	600
Vivid	7.5	95 (R9=95)	490

\*Lumens vary depending on color temperature - results for 3000K lamp used above.

### Ordering Matrix

Model	CRI	Color Temperature	Color	Mounting Options	Accessories
TS05	90 95	27 = 2700K 30 = 3000K	B=Black W=White S=Silver CC=Custom Color	See Mounting Options for Ordering Codes	See Accessory Options for Ordering Codes

**Example:** TS05-95-27-B-ADI-LV1

TS05- \_\_\_\_\_ - \_\_\_\_\_ - \_\_\_\_\_ - \_\_\_\_\_ - \_\_\_\_\_

\* Specification sheets are subject to change without notice.

## Photometric Data

### 10° Degree Beam

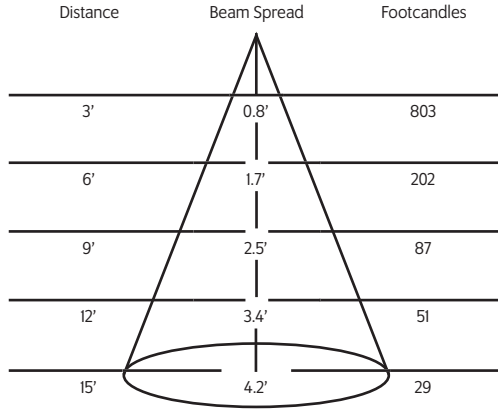

### 25° Degree Beam

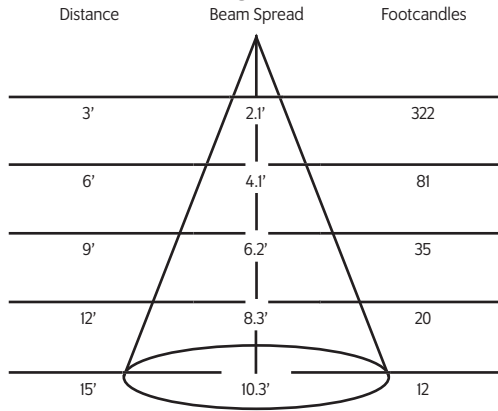

### 36° Degree Beam

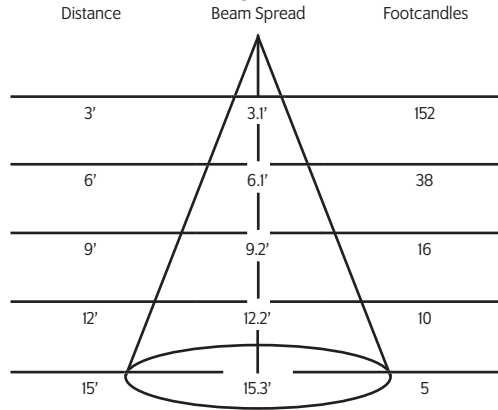

### 60° Degree Beam

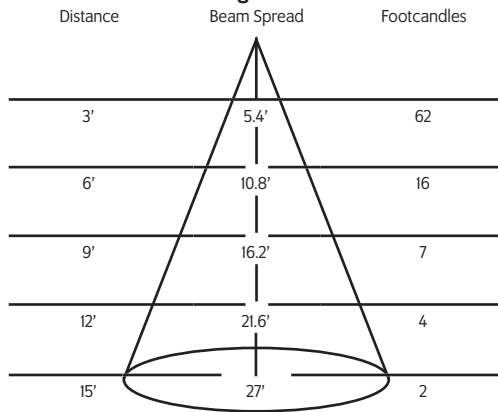

\* Calculated with a 3000K 80 CRI lamp.

## Mounting Options

**AD1** Track Adapter for commercial grade 1-circuit track. 120V. For use with lightweight fixtures.

**TA2** Track adapter for G-Series specification grade 2-circuit track. 120V.

**TA3** Track adapter for G-Series specification grade 3-circuit track. 120V.

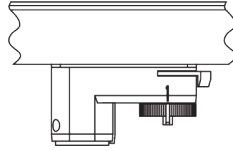

**CM1** Canopy Mount

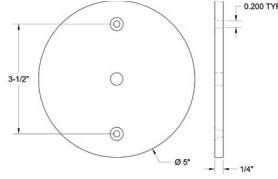

**US1** 6<sup>5</sup>/<sub>8</sub>" x 1<sup>1</sup>/<sub>2</sub>" Unitsrut Adapter



## Snap Accessories

- 00325** 25° Beam Spreader Snap
- 00327** 36° Beam Spreader Snap
- 00329** 60° Beam Spreader Snap
- 00331** 10°-25° Linear Snap
- 00333** 10°-36° Linear Snap
- 03259** 10°-60° Linear Snap
- 00335** 25°X25° Flat Top Snap
- 00337** 36°X36° Flat Top Snap
- 00339** 40° Cutoff Louver
- 00325** 20° Maximum Deflection Snap
- 00323** ¼ Color Temperature Shift Snap
- 0032** ½ Color Temperature Shift Snap
- 00319** ¾ Color Temperature Shift Snap
- 03281** Enhance Snap
- 02183-C** Color Snap (Specify Color)

## Fixture Accessories

- LVI** Louver
- DFI** Dichroic Color Filter

## Extension Wands

- SP 12** 12" Stem
- SP 18** 18" Stem
- SP 24** 24" Stem
- SP X** Custom Length