



Manufactured in the USA - IBEW

PRODUCT LISTED  
BY A NATIONALLY  
RECOGNIZED  
TESTING  
LABORATORY



**SORAA**<sup>®</sup>  
Simply Perfect Light™

**Features:**

- Accepts PAR16 and PAR20 lamps and LEDs
- Numerous mounting options and accessories
- **Weight:** 1.8 lbs

**P20**  
SORAA LED PAR20



5 Holt Drive,  
Stony Point, NY 10980  
845-947-3034  
info@tslight.com

The P20 features an adjustable head and an external accessory holder that accepts louvers, barndoors, hoods and a variety of filters. Available in standard black, white and silver finishes. Custom colors are available by request and at an additional charge.

By utilizing Soraa's Snap System, unlimited possibilities for customizing this fixture are available. Options include the ability to field change the beam angle (Beam Spreader Snap), color temperature (CTO Snap), or to add a louver. Color Snaps can be used to produce brilliant hues of any color that Rosco or Lee offer.

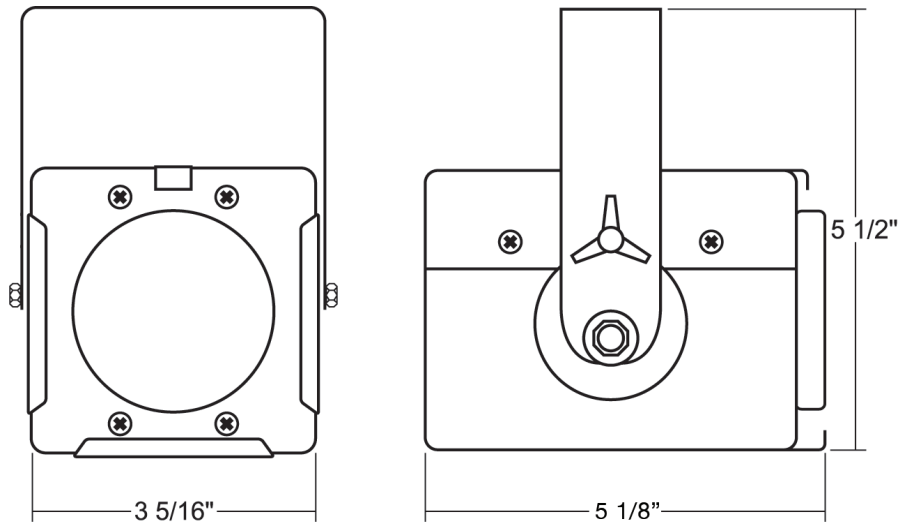

**LED Lamp Types**

Lamp Type	CCT	Watts	CRI	Lumens
Vivid	2700K	11	95	500
Vivid	3000K	11	95	540
Brilliant	2700K	8.5	92	700
Brilliant	3000K	8.5	92	730

**Ordering Matrix**

Model	CRI	CCT	Color	Mounting Options	Accessories
<b>P20</b>	95 92	27 = 2700K 30 = 3000K	B=Black W=White S=Silver CC=Custom Color	See Mounting Options for Ordering Codes	See Accessory Options for Ordering Codes

\*All fixtures sold with 10° beam angle lamps – use Beam Spreaders to achieve desired angle.

**Example:** P20-9527-B-ADI-LV3

P20-\_\_\_\_\_ - \_\_\_\_\_ - \_\_\_\_\_ - \_\_\_\_\_

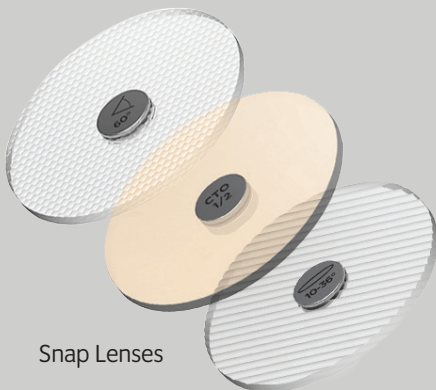

Snap Lenses

\*Specification sheets are subject to change without notice.

## Photometric Data

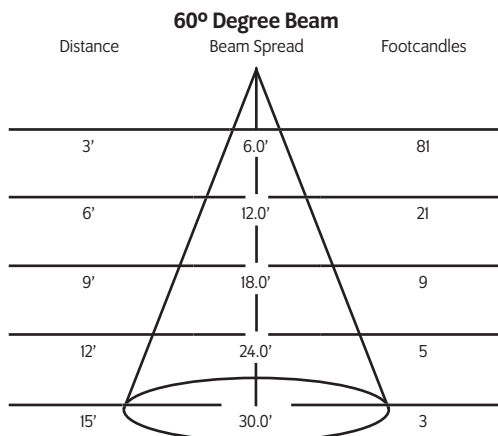
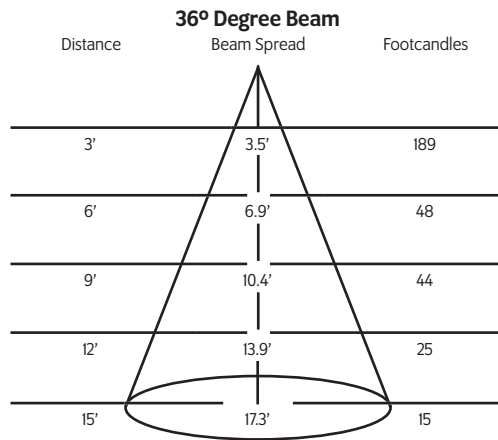
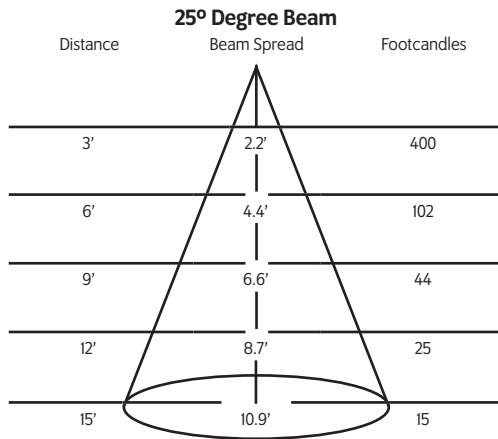
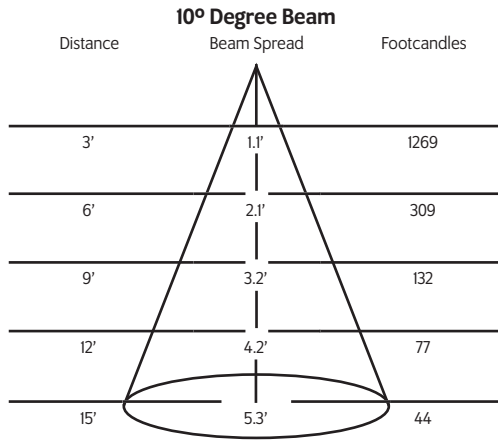

\*Beam spread calculated based on field diameter.

## Mounting Options

**AD1** Track Adapter for commercial grade 1-circuit track. 120V. For use with lightweight fixtures.

**TA2** Track adapter for G-Series specification grade 2-circuit track.

**TA3** Track adapter for G-Series specification grade 3-circuit track.

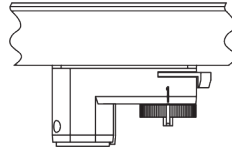

**US1** Unistrut adapter.

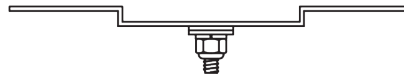

**CM1** Low profile canopy for permanent mounting on standard 4" electrical boxes.

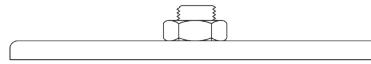

**MC** Medium duty pipe clamp for pipes up to 1 1/2" O.D.

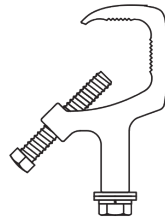

**MN** Medium duty pipe clamp for pipes up to 2" O.D.

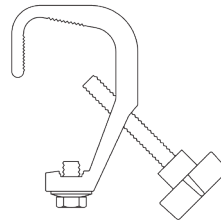

## Accessories

<b>BD4</b>	Barndoor
<b>LV4</b>	Full Size Louver
<b>HD4</b>	Hood/Snoot
<b>CC18</b>	Coil Cord Option
<b>SC-24</b>	Safety Cable
<b>CF4</b>	Color Frame
<b>GF4</b>	Glass Color Filter
<b>DF4</b>	Dichroic Color Filter
<b>GF4-600</b>	5°x50° Linear Lens
<b>GF4-601</b>	Beam Softener
<b>GF4-673</b>	50°x50° Spread Lens

## Snap Accessories

<b>00325</b>	25° Beam Spreader Snap
<b>00327</b>	36° Beam Spreader Snap
<b>00329</b>	60° Beam Spreader Snap
<b>00331</b>	10°-25° Linear Snap
<b>00333</b>	10°-36° Linear Snap
<b>03259</b>	10°-60° Linear Snap
<b>00335</b>	25°x25° Flat Top Snap
<b>00337</b>	36°x36° Flat Top Snap
<b>00339</b>	40° Cutoff Louver
<b>00325</b>	20° Maximum Deflection Snap
<b>00323</b>	1/4 Color Temperature Shift Snap
<b>0032</b>	1/2 Color Temperature Shift Snap
<b>00319</b>	3/4 Color Temperature Shift Snap
<b>03281</b>	Enhance Snap
<b>02183-C</b>	Color Snap (Specify Color)

## Extension Wands

<b>SP 12</b>	12" Stem
<b>SP 18</b>	18" Stem
<b>SP 24</b>	24" Stem
<b>SP X</b>	Custom Length