

BTX7 6.5W

720 Lumen LED



5 Holt Drive,
Stony Point, NY 10980
845-947-3034
info@tslight.com

The BTX7 is designed around the Xicato™ LED remote phosphor module. This module produces an even field of illumination for the most demanding applications. The BTX7 is ideal for museum and retail lighting where a low wattage, high output LED fixture would be required. Xicato™ LEDs exceed ANSI specifications by maintaining tight color consistency over the life of the LED module.

The BTX7 is available in standard black, white, or silver finishes. Custom colors are available upon request.

Manufactured in the USA - IBEW



XICATO

Construction

- Steel housing with black, white or silver finish
- Accepts up to 3 accessories
- Weight: 2.5 lbs.

Dimming

- Trailing edge (ELV): 120V only
- Leading edge (Triac): 120V only
- 0-10V: 120-277V with surface mounting. For track applications, use E-series 2-circuit with data bus

Electrical

- Integral electronic driver
- 100-277V, 50/60Hz
- Meets FCC 47 CFR Part 15/18 Requirements

Optics

- 20°, 40°, and 60° Field-changable reflectors
- CBCP: 2900 @ 20°
1700 @ 40°
930 @ 60°

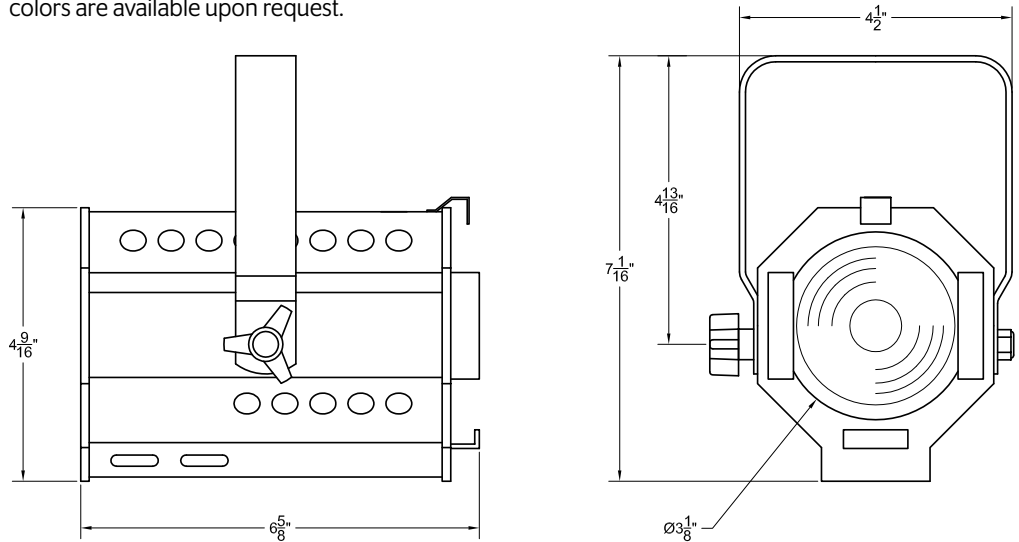

LED

- Xicato™ cold remote phosphor LED module
- Color temp options: 2700K, 3000K, 3500K, 4000K
- CRI: 83 standard or 98 optional (R9=96)
- Lumen maintenance: 86% of initial lumen output at 50,000 hours on LM-80 testing
- SDCM: 1 x 2 MacAdam Ellipse. 50 kelvin tolerance
- No UV or IR

Module	Total Wattage*	Delivered Lumen	Efficacy (Lm/W)	CRI
83	6.5	720	129	83
98	8.5	720	79	98

* Total wattage equals LED plus driver. Delivered lumen may vary depending on LED module, color temperature, optics, and accessories.

Ordering Matrix

Model	LED Module	Color Temp	Finish	Voltage	Optics	Mounting	Dimming*	Accessories
BTX7	83	27 = 2700K	B = Black	100	20 = 20°	See Mounting Options	TE = Trailing Edge LE = Leading Edge 010 = 0-10V ND = Non-Dimming	See Accessory Options
	98	30 = 3000K	W = White	120	40 = 40°			
		35 = 3500K	S = Silver	240	60 = 60°			
		40 = 4000K	CC = Custom Color	277	ZO = Zoom Optic			

Maximum ambient temperature: 35°C
Maximum operating angle: 45° from vertical

* See "Notes on Dimming" on reverse

Example: BTX7-83-27-B-120-40-T1-LE-LV5

BTX7- _____ - _____ - _____ - _____ - _____ - _____ - _____

* Specification sheets are subject to change without notice.

Photometric Data 3000° K 83CRI

20° Spot Reflector

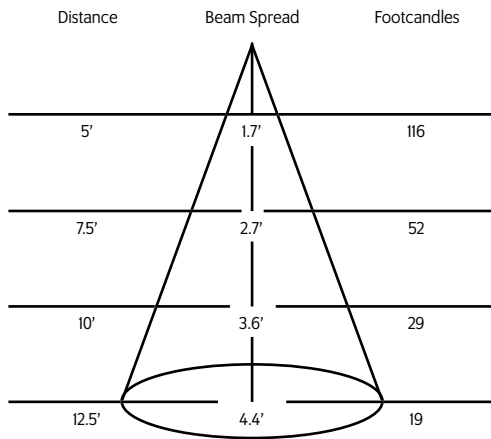

40° Medium Flood Reflector

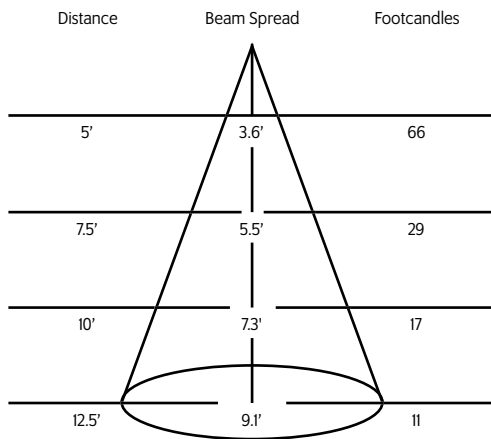

60° Flood Reflector

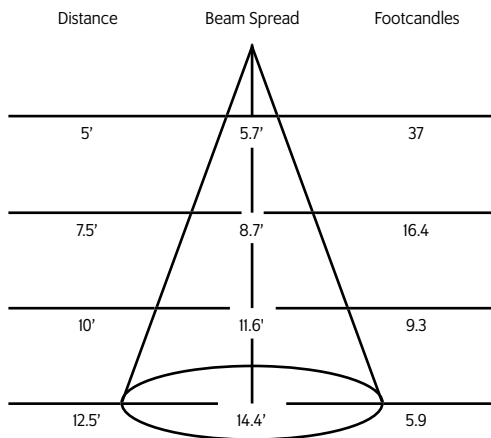

Mounting Options

DT2 2-circuit track adapter for SpecTrack databus. 120V

HDT2 Track adapter for SpecTrack 2-Circuit data track. 277V.

AD1 Track Adapter for commercial grade 1-circuit track. 120V. For use with lightweight fixtures.

HTA2 Track adapter for G-Series specification grade 2-circuit track. 277V.

TA3 Track adapter for G-Series specification grade 3-circuit track. 120V.

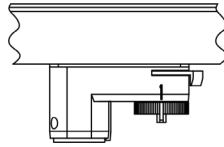

CM4 Canopy Mount

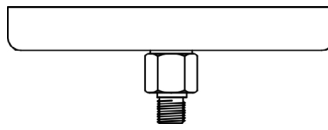

US1 6⁵/₈" x 1¹/₂" Unistrut Adapter

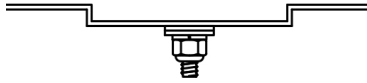

TB4 6¹/₄" Portable wall mount/table base floor, wall or table use.

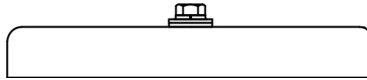

MC Light duty pipe clamp for small fixtures. For pipes up to 1 5/16" O.D.

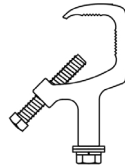

MN Medium duty pipe clamp for small to large fixtures. For pipes up to 2" O.D.

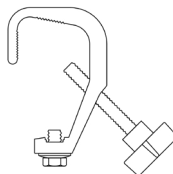

PC9M Heavy duty pipe clamp for large, heavy fixtures. For pipes up to 2" O.D.

Accessories

LV5	Louver
BD5	Barndoor
HD5	Hood
CF5	Color Frame
GF5	Glass Color Filter
X00517	Accessory Holder
FX22-26	Red Filter
FX22-80	Blue Filter
FX22-64	Light Blue Filter
FX22-90	Green Filter
FX22-21	Amber Filter
FX22-10	Yellow Filter
FX22-33	Pink Filter
DF5	Dichroic Color Filter
GF5-600	5°x50° Linear Lens
GF5-601	Beam Softener
GF5-673	50°x50° Spread Lens
CC18	Coiled Cord
SC-24	Safety Cable

Extension Wands

SP 12	12" Stem
SP 18	18" Stem
SP 24	24" Stem
SP X	Custom Length