

SpecTrac DATA 0-10V-DMX

120V 2-CIRCUIT TRACK

Times Square Lighting's SpecTrac features a low voltage busway for transmitting a DMX, 0-10V, or DALI control signal. SpecTrack is a two circuit/two neutral lighting track that features a robust extrusion, high quality connectors and components, and multiple mounting options.



5 Holt Drive
Stony Point, NY 10980
845-947-3034
www.tslight.com

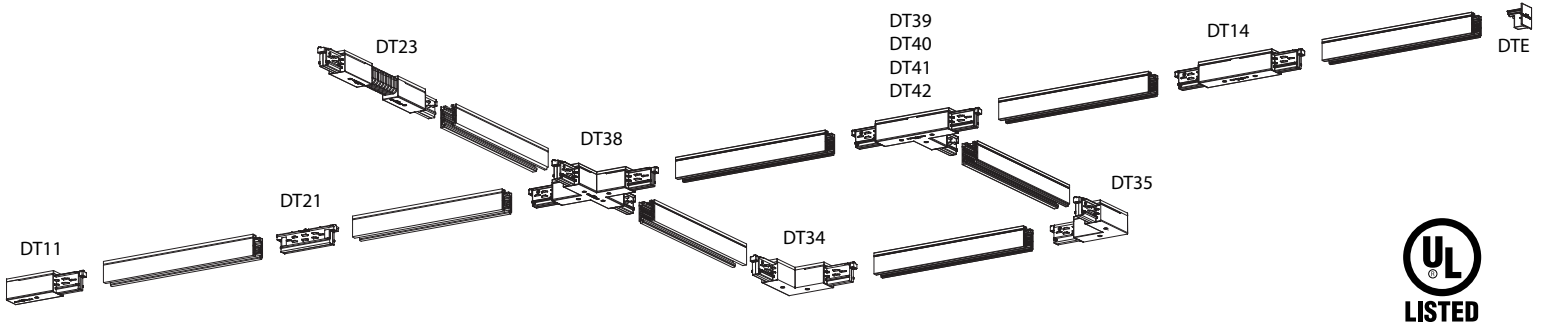

**There is only one control bus on the track, therefore, all circuits will be sharing the same control signal.*

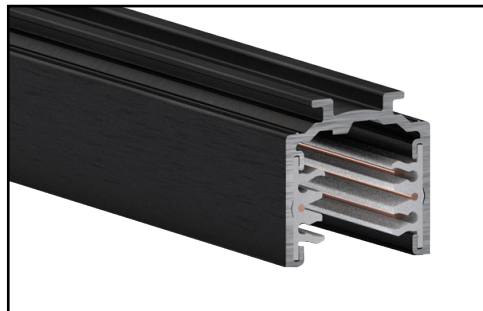
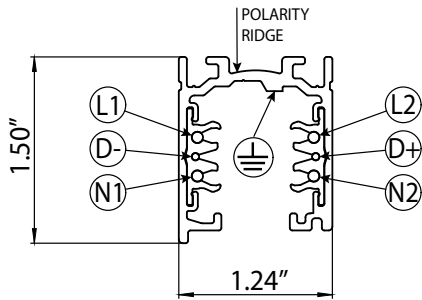

STANDARD (SURFACE / PENDANT MOUNT)

ORDERING CODE	LENGTH	COLOR
DT4B	4 ft.	B = Black
DT4W	4 ft.	W = White
DT6B	6 ft.	B = Black
DT6W	6 ft.	W = White
DT8B	8 ft.	B = Black
DT8W	8 ft.	W = White
DT12B	12 ft.	B = Black
DT12W	12 ft.	W = White

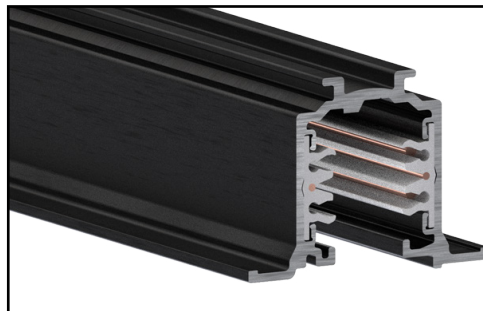
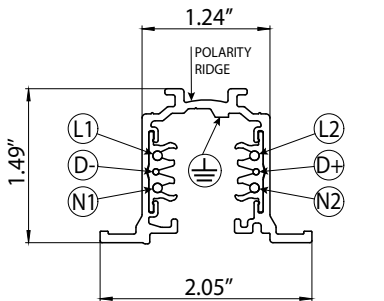

RECESSED (FLANGED)

ORDERING CODE	LENGTH	COLOR
RDT4B	4 ft.	B = Black
RDT4W	4 ft.	W = White
RDT8B	8 ft.	B = Black
RDT8W	8 ft.	W = White

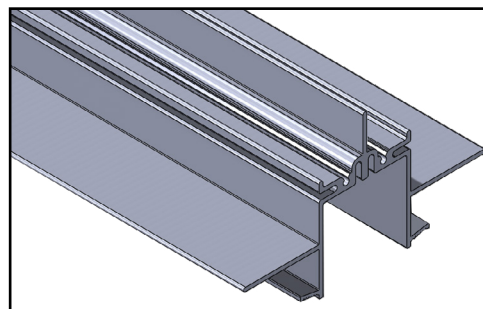
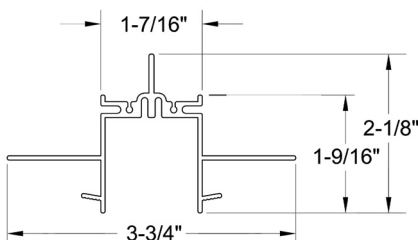

FLANGLSS TRACK SLEEVE

** To be used with the Standard (Surface / Pendant Mount) Track*

ORDERING CODE	LENGTH
FTPX-44	4 ft.
FTPX-48	8 ft.

L FEED



ORDERING CODE	POLARITY RIDGE*	COLOR
DT34B		B = Black
DT34W		W = White

Used for corners, can be used as a feed point.

DT35B		B = Black
DT35W		W = White

X FEED



ORDERING CODE	POLARITY RIDGE*	COLOR
DT38B		B = Black
DT38W		W = White

Used for grid layouts, can be used as a feed point.

END FEED



ORDERING CODE	POLARITY RIDGE*	COLOR
DT11B		B = Black
DT11W		W = White

End feed for power and data.

CENTER FEED



ORDERING CODE	COLOR
DT14B	B = Black
DT14W	W = White

Connector to join two pieces of track, can be used as a feedpoint.

END CAP

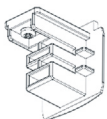

ORDERING CODE	COLOR
DTEB	B = Black
DTEW	W = White

Used to end a track configuration.

DATA TERMINATOR



ORDERING CODE	POLARITY RIDGE*	COLOR
DT11-TERM-B		B = Black
DT11-TERM-W		W = White

Used to terminate DMX configuration. 120 Ohm resistor installed.

T FEED

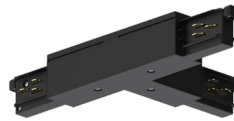

ORDERING CODE	POLARITY RIDGE*	COLOR
DT39B		B = Black
DT39W		W = White

Used for grid layouts, can be used as a feed point.

DT40B		B = Black
DT40W		W = White

DT41B		B = Black
DT41W		W = White

DT42B		B = Black
DT42W		W = White

MIRROR END FEED



ORDERING CODE	POLARITY RIDGE*	COLOR
DT13B		B = Black
DT13W		W = White

Mirror end feed for power and data.

STRAIGHT CONNECTOR



ORDERING CODE	COLOR
DT21B	B = Black
DT21W	W = White

Connector to join two pieces of track, can not be used as a feedpoint.

FLEXIBLE CORNER CONNECTOR



ORDERING CODE	COLOR
DT23B	B = Black
DT23W	W = White

180° range of flexibility along both vertical and horizontal planes. (Ceiling to ceiling and ceiling to wall)

DATA TERMINATOR MIRROR



ORDERING CODE	POLARITY RIDGE*	COLOR
DT13-TERM-B		B = Black
DT13-TERM-W		W = White

Used to terminate DMX configuration. 120 Ohm resistor installed.

ACCESSORIES *(Add suffix B-Black, W-White)*

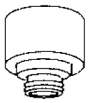

XTSAJ 10 Conduit Adapter

Used to attach power to any live feed.



TOOL FOR CUTTING CONDUCTORS

Tool necessary for trimming conductors after field cutting track.



Convenience Outlet

DT2-PC PowerCon

DT2-ED Edison

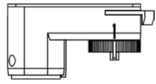

DT2-TERM

Terminating Resistor Retrofit.

ORDERING CODE

DTCT



Convenience Data Outlet

DT2-XLR5 5-Pin XLR

DT2-XLR3 3-Pin XLR

SUSPENSION AND MOUNTING COMPONENTS *(Add suffix B-Black, W-White)*

3/8" Stem and canopy kit for mechanical and electrical suspension.

12 in. SPUS 12

18 in. SPUS 18

24 in. SPUS 24

36 in. SPUS 36

48 in. SPUS 48

Custom lengths available.

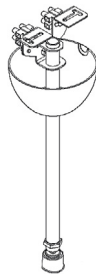

SPNF

Point suspension bracket for mechanical connection only. Can be used when cutting stems to length in field. Accepts 3/8th-inch rigid stem.

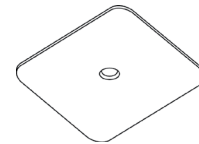

GES 15 J-Box Cover

Used to cover an outlet box.



SPLF-M

"L" suspension bracket for mechanical connection to the track.



SBPRK2P

Two-piece cable and pendant clip. Accepts 1/4"- 20 threaded rod.



SPEF-M

End feed suspension bracket for mechanical connection to the track.



SPXF-M

"X" suspension bracket for mechanical connection to the track.



SPCF-M

Center feed suspension bracket for mechanical connection to the track.



SPTF-M

"T" suspension bracket for mechanical connection to the track.

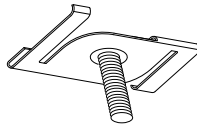

SKBX-12

Grid Clip.

Cable Kit w/Canopy

(Add suffix B-Black, W-White)

24 in. CG 24

48 in. CG 48

72 in. CG 72

Custom lengths available.



RECESSED CONNECTOR COVERS *(Add suffix B-Black, W-White)*

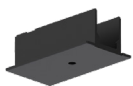

RDT11

Live end cover for recessed configurations. Use with DT11 / DT12.

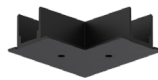

RDT34

L-feed cover for recessed configurations. Use with DT34 / DT35.

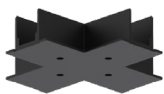

RDT38

X-feed cover for recessed configurations. Use with DT38.



RDTE

Recessed End Cap

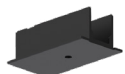

RDT14

Center feed cover for recessed configurations. Use with DT14.

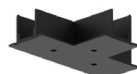

RDT39

T-feed cover for recessed configurations. Use with DT39 / DT40 / DT41 / DT42.

TRACK CURRENT LIMITERS

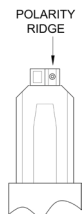

Times Square Track Current Limiters are designed to provide an answer to energy limitations on wattage-per-foot requirements for lighting track installations. For more information, please see the Current Limiters specification sheet:

<http://www.tslight.com/resources/send/8-current-limiters/201-tsc-current-limiters>

Guidelines for Track System Layouts

Complex layouts often have more than one feed point, and the potential exists for short or crossed circuits. The first diagram below shows how short or crossed circuits can be created. The second diagram below illustrates how short circuits can be avoided.

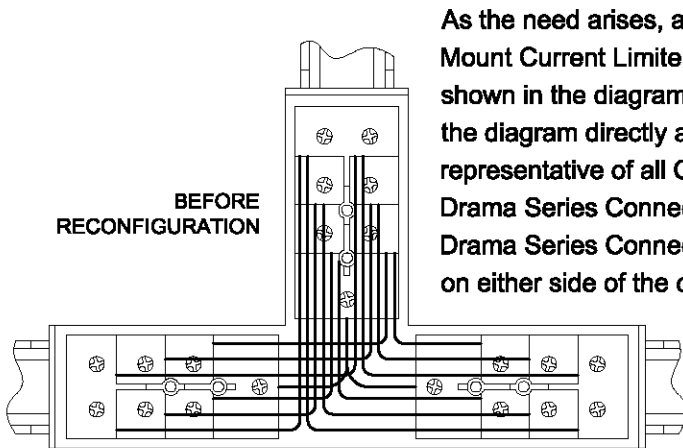
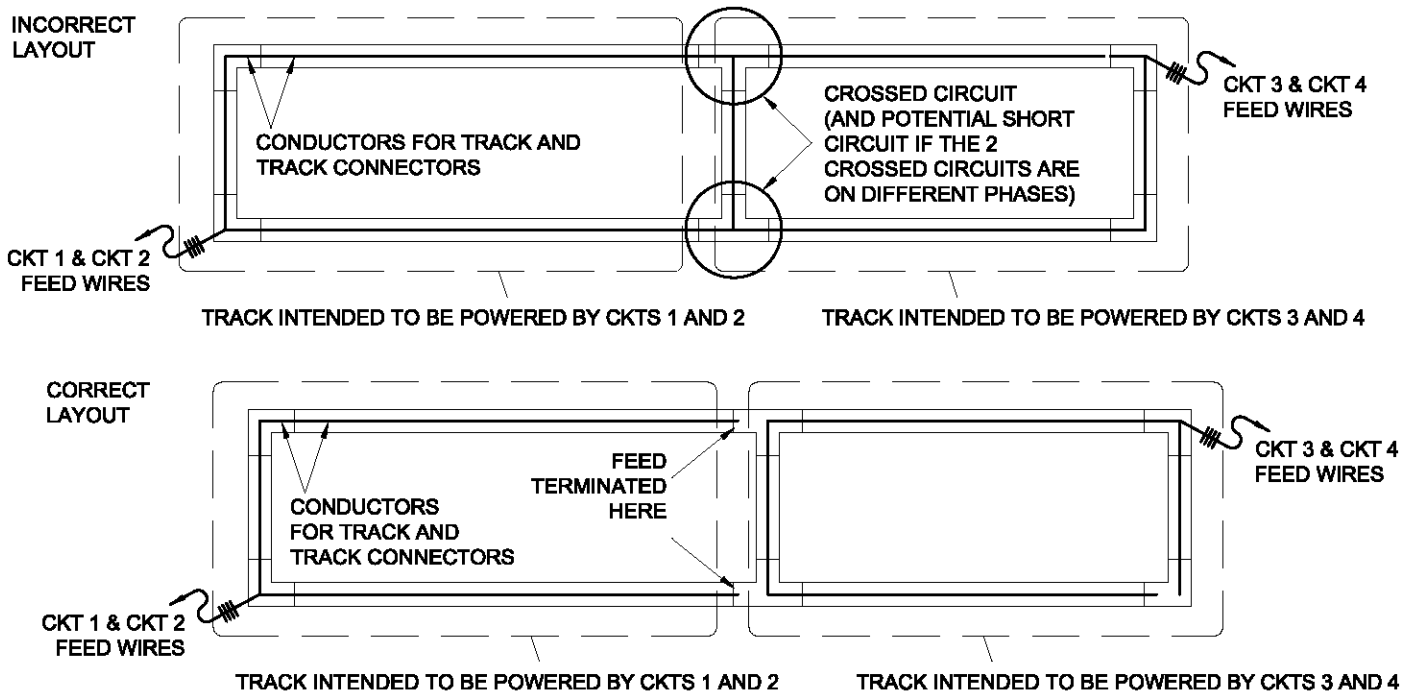

As the need arises, all Connector types and all Surface/Suspension Mount Current Limiters can be opened and reconfigured. The Connector shown in the diagrams below would be typical of a T Connector used in the diagram directly above, after it has been reconfigured. It is representative of all Connector types to be used in any layout. All but the Drama Series Connectors can be accessed by removing their covers. Drama Series Connectors can be accessed by removing the two screws on either side of the connector and sliding the Connector out from its housing. NOTE: Ground wires should be left undisturbed for ALL Connector types.

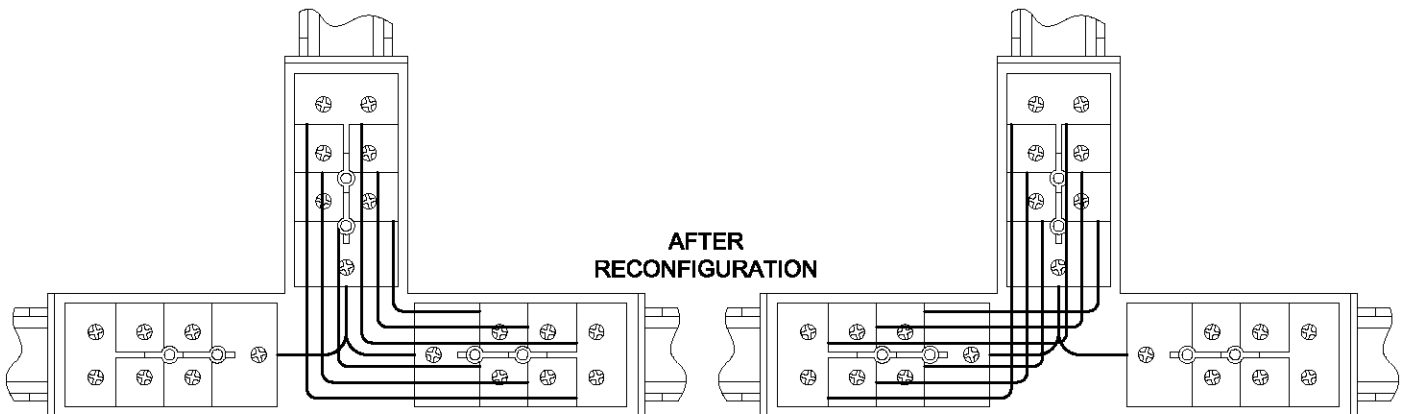

Continued on next page

Guidelines for Track System Layouts (Continued)

It is good practice to eliminate wiring loops for power conductors and the control bus conductors on complex layouts. The first diagram below shows how loops are created, with a typical loop highlighted for clarity. The second diagram below illustrates how loops can be avoided. Complex layouts using DMX control wiring will be discussed on the next two pages. Also, see Page 17 for more requirements on Data Track using 0-10V control and DALI.

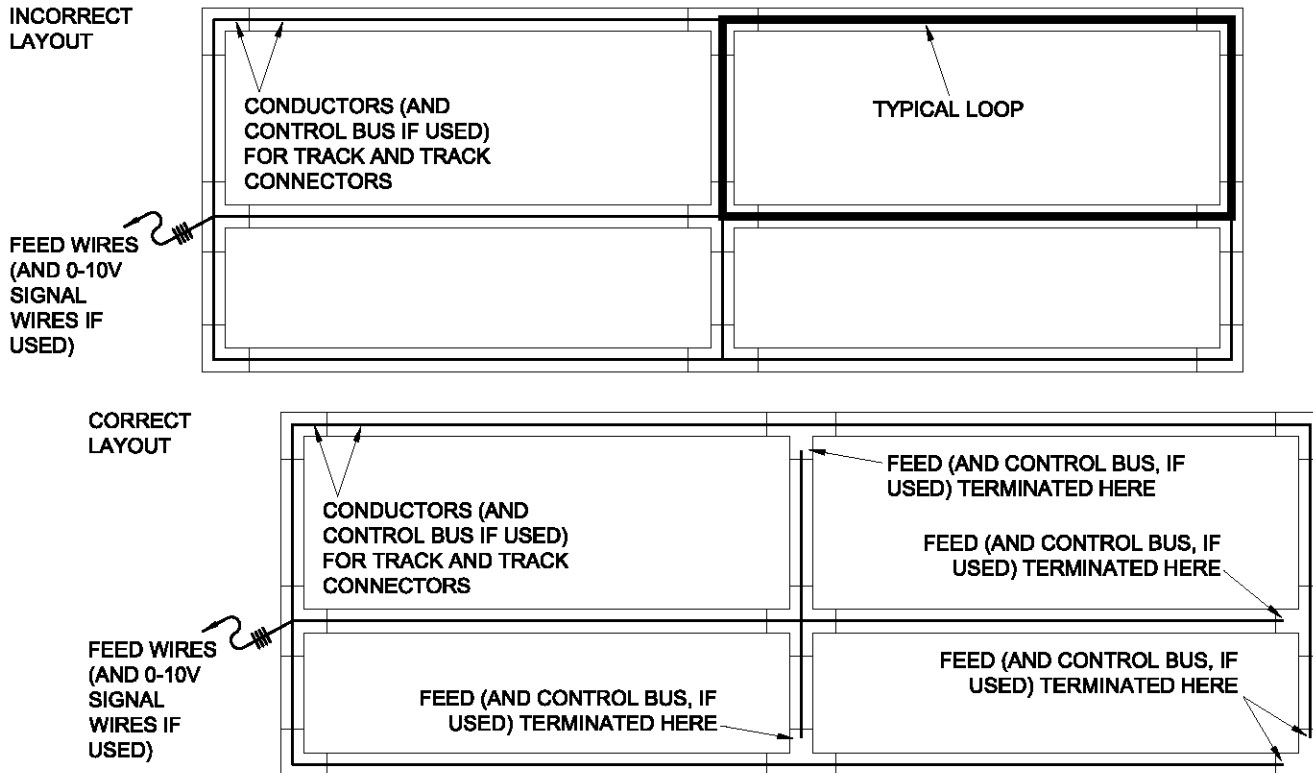

As previously stated, all Connector types and all Surface/Suspension Mount Current Limiters can be opened and reconfigured. The Connector shown in the diagrams below would be typical of a T Connector used in three places in the diagram directly above, after it has been reconfigured. It is representative of all Connector types to be used in any layout. All but the Drama Series Connectors can be accessed by removing their covers. Drama Series Connectors can be accessed by removing the two screws on either side of the connector and sliding the Connector out from its housing. See inset directly below.
NOTE: Ground wires should be left undisturbed for ALL Connector types.

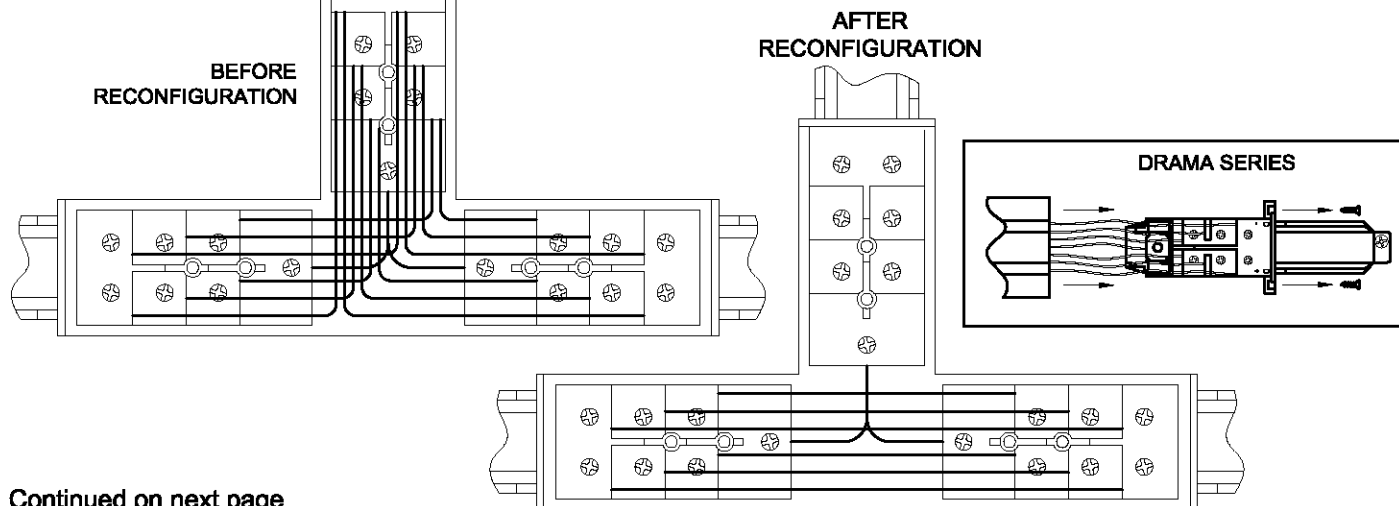

Continued on next page

Guidelines for Track System Layouts (Continued)

It is imperative that all DMX control wiring on any layout be run in a daisy chain fashion. No loops or branches such as T's or X's are allowed. The layout possibilities are endless, but the diagrams below show the basics of how loops and branch circuits are avoided. See the next page for more requirements on Data Track using DMX control.

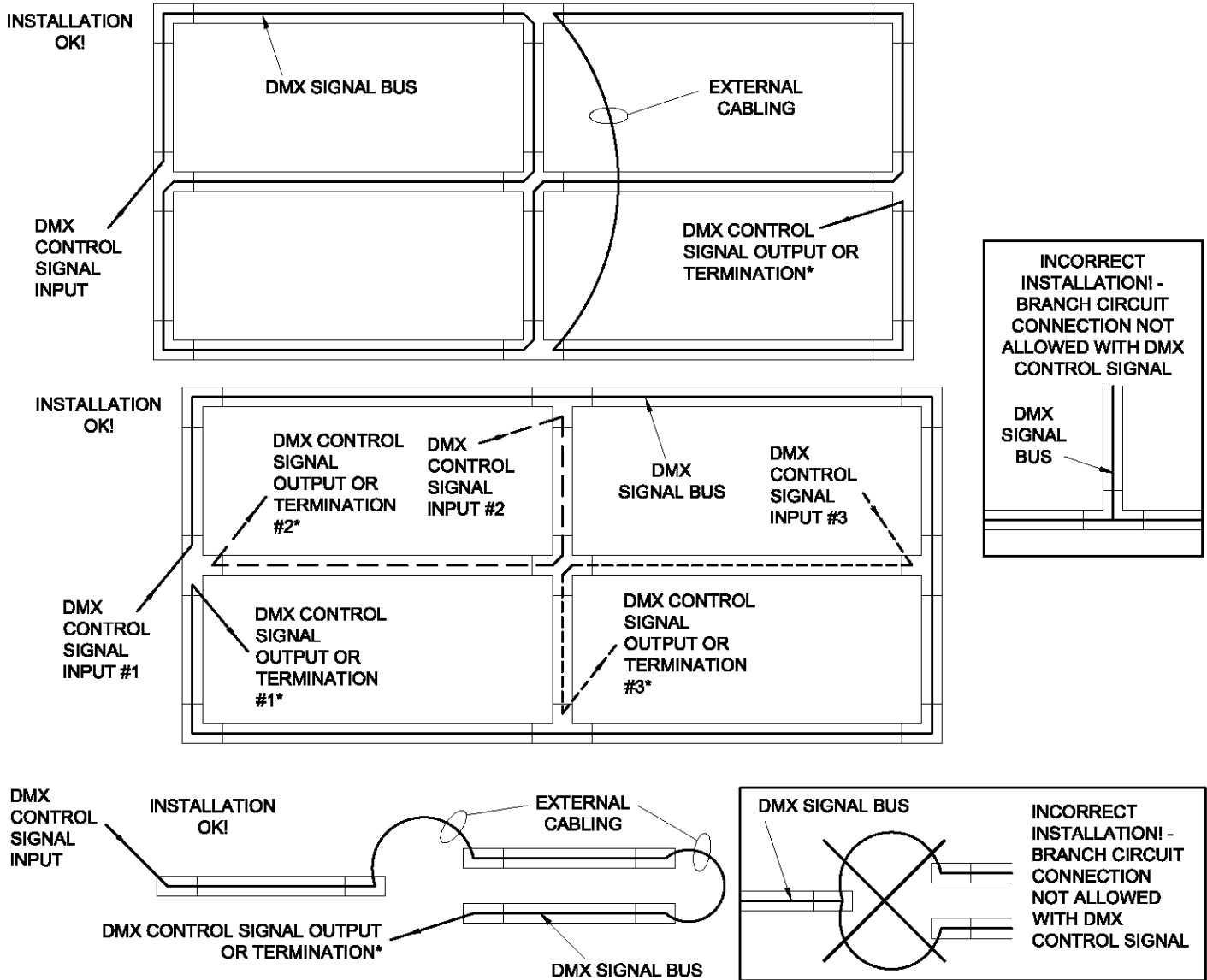

* All DMX control runs must be terminated with a 120 Ω resistor. If the end of the DMX control run is within the track layout, then this can be accomplished in two ways: 1) By adding a track adapter with a terminating resistor pre-installed at the very end of the track, closest to the last connector or the dead end in the run (All track adapter types are available with resistors installed from the factory by adding "-TERM" at the end of the part number), or, 2) By installing the resistor across the D+ and D- screw terminals on the last connector in the run (All Live Ends and Mirror Live Ends types are available with resistors installed from the factory by adding "-TERM" at the end of the part number). See diagrams to right. The polarity of the resistor does not matter.

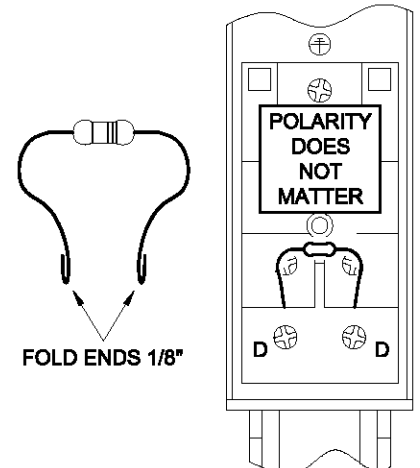

Continued on next page

Guidelines for Track System Layouts (Continued)

SPECIAL CONSIDERATIONS FOR DMX CONTROL

DMX control runs should be limited to 1000 feet maximum, including track and all intermediate control cabling. There should be no more than 32 fixtures and devices (including splitters) on a single DMX control run. The control bus in the track has a capacitance that can affect signal integrity compared to runs composed of cable only. Therefore, when using fixtures with DMX that have Remote Device Management (RDM) capability, there should be no more than 20 fixtures and devices (including splitters) on a single DMX/RDM control run.

The control bus in the track has only two conductors. Typical DMX systems consist of three conductors: Data +, Data - and Signal Common. If the intermediate control cabling to, from, or between the track consists of shielded twisted pairs, then the shield is Signal Common. The Signal Common when using this track is not used. Make certain that NO portion of the shield or shield wire (aka drain wire) is connected to the track, or bonded to or incidentally in contact with Ground, or anything electrically connected to Ground. If the intermediate control cabling to, from, or between the track consists of unshielded twisted pairs, such as Cat5, Cat5e, Cat6 or Cat6e, then only the Orange / White (Data +) and the Orange (Data -) wires are to be used. See chart below.

Data Track Connector	Shielded Twisted Pair with Standard DMX Connector (XLR)	Unshielded Twisted Pair (Cat5, Cat5e, Cat6 or Cat6e)
D+	Data + [Any Color], Pin 3 on XLR Conn.	Orange / White
D-	Data - [Any Color], Pin 2 on XLR Conn.	Orange
not used	Signal Common (bare drain wire), Pin 1 on XLR Conn.	Brown / White

Depending on the polarity of the Connector, D+ and D- are located as shown below:

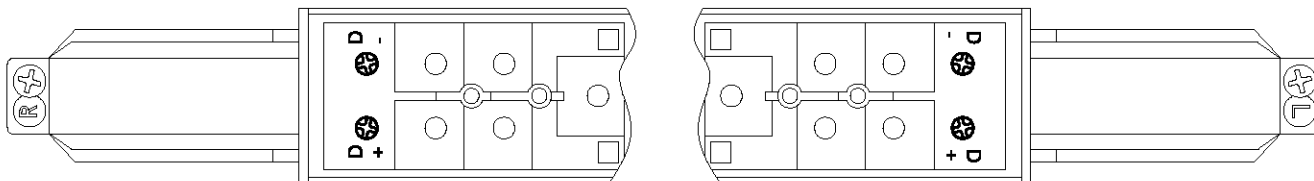

SPECIAL CONSIDERATIONS FOR 1-10V CONTROL

It is important to remember that although all track has multiple power circuits, there is only one signal bus circuit. For fixtures requiring 0-10V dimming controls, all fixtures connected to the 0-10V bus will receive the same dimming signal regardless of what power circuit they are on. The maximum number of fixtures on a control run depends on the 0-10V control device that is used.

SPECIAL CONSIDERATIONS FOR DALI CONTROL

The maximum control run between the first and the last DALI components may not exceed 984 feet. The maximum number of fixtures on a control run depends on the DALI control device that is used. The DALI standard specifies a voltage of 16V DC (typical), 22.5V DC MAX and a current of 250mA. The voltage drop may not exceed 2V. DALI fixtures should have a maximum consumption of 2mA. DALI control wiring on any layout may be run in a daisy chain or a star arrangement or in mixed form. The control signal has no polarity.

Continued on next page

Guidelines for Track System Layouts (Continued)

PROBLEMATIC SUSPENDED LAYOUTS

Certain *suspended* track layouts, employing long lengths of Pendants, Wire Cable, or 1/4"-20 Threaded Rod, may deform, twist or splay. This condition sometimes worsens with the additional weight of fixtures. Arcs suspended with Wire Cable being especially problematic. Track layouts of closed loops are more stable, and less apt to deform. Also, layouts using Adjustable Joiners (hexagons, octagons, etc.) may deform without custom stiffeners. Consult factory for guidance.

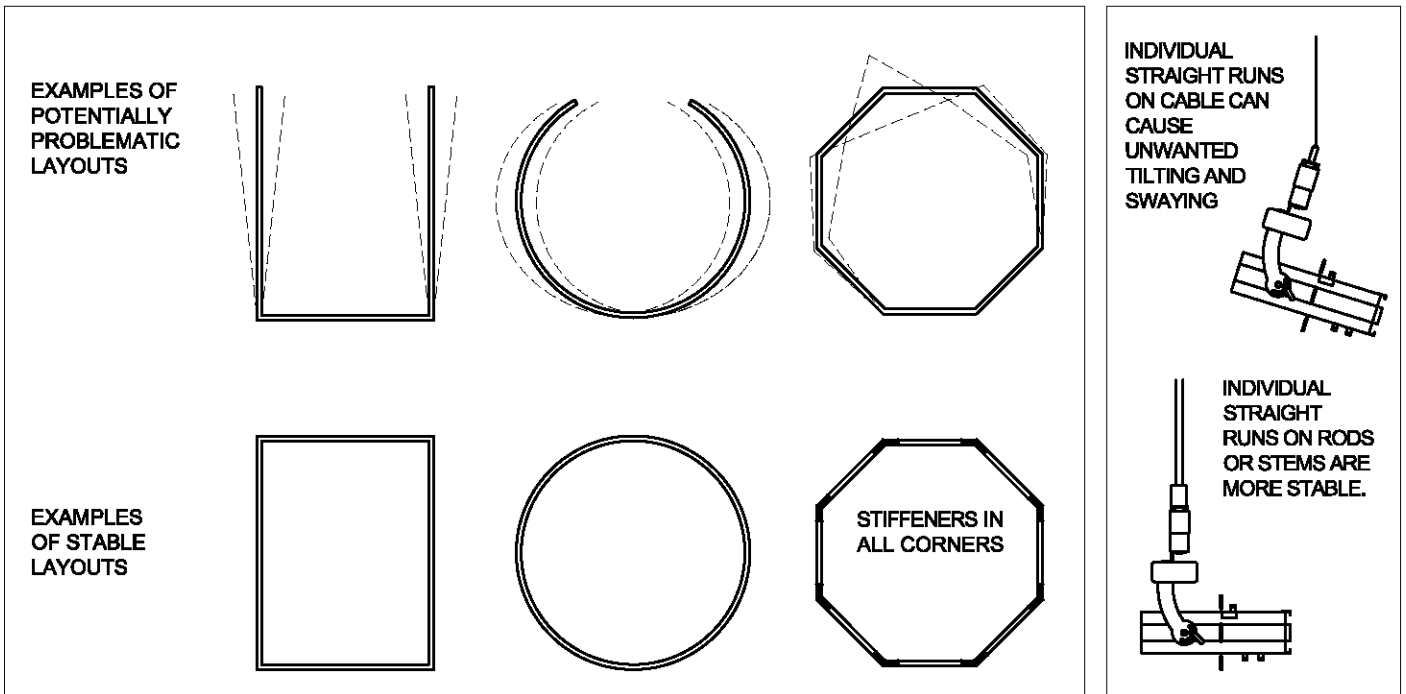

Often there is a need to suspend track using supports that are more than 4 feet apart. Per the NEC, *track* supports, whether they be pendants, threaded rod, etc., must be provided a maximum of every 4 feet along the length of the track section. One solution is to mount the track as code allows directly to low profile strut channel or the like, and then support the channel up to whatever the maximum span would be allowed by the authority having jurisdiction. The diagram below illustrates how an 8' track section can be suspended with two supports only.

