



# CR Recessed Series

## Specification Sheet - New Construction



5 Holt Drive,  
Stony Point, NY 10980  
845-947-3034  
info@tslight.com

Manufactured in the USA - IBEW

PRODUCT LISTED  
BY A NATIONALLY  
RECOGNIZED  
TESTING  
LABORATORY



### Features

- 100,000 Hour life per LED
- 20°, 40°, and 60° Field-changeable reflectors
- Choice of color temperatures: 2700° K, 3000°K, 3500°K, 4000°K, 5000°K, 5700°K, & 6500°K.
- Blends into the ceiling and can be installed with or without trim
- Each LED is individually mounted for up to 45° pan and tilt
- Accepts a variety of lenses and accessories
- Adjustable trim with torsion springs for ceilings up to 2" thick
- Adjustable butterfly mounting brackets included
- Fully enclosed wiring compartment
- Black, white and silver trims available - custom colors upon request

### Dimming

- Trailing edge (ELV): 120V / 277V
- Leading edge (Triac): 120V only
- 0-10V: 120V only (ControlTrac), 120-277V otherwise
- Lutron ecosystem premier driver available, featuring dimming to 0.1% and soft on/soft off incandescent like dimming. Only available on fixtures 20 watts or less.
- DMX-addressing done via RDM or preset at factory. Dims to 0.1%.

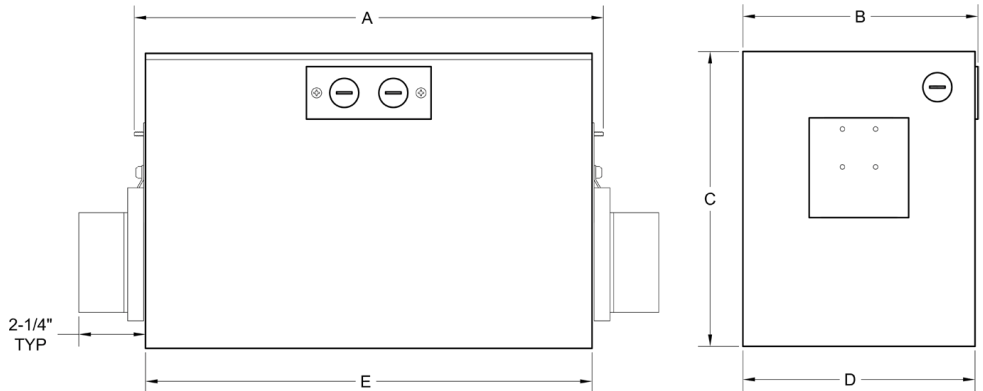

### LED

- Cree XLamp LED array
- Color temp options: 2700K, 3000K, 3500K, 4000K, 5000K, 5700K, 6500K
- CRI: 80 standard or 92 optional
- Lumen maintenance: 90% of initial lumen output at 33,000 hours on LM-80 testing
- No UV or IR

Model	CRI	Total Wattage	Delivered Lumens	Efficacy (Lm/W)
CR9	80 / 92	5.6 / 6.4	900 / 900	161 / 141
CR12	80 / 92	7.7 / 9.0	1200 / 1200	156 / 133
CR15	80 / 92	9.7 / 11.4	1500 / 1500	155 / 132
CR18	80 / 92	11.4 / 15.0	1800 / 1800	158 / 120
CR20	80 / 92	13.3 / 15.8	2000 / 2000	150 / 127
CR25	80 / 92	18.0 / 23.4	2500 / 2500	139 / 107
CR27	92	25.0	2700	108
CR30	80	23.4	3000	128

Model #	Length	Width	Height	Ceiling Cut-Out	
	(A)	(B)	(C)	(D)	(E)
CR20R-1	8 1/2"	7 1/2"	9"	7 3/16"	8"
CR20R-2	14 1/2"	7 1/2"	9"	7 3/16"	14"
CR20R-3	20 3/8"	7 1/2"	9"	7 3/16"	20"
CR20R-4	26 1/4"	7 1/2"	9"	7 3/16"	25 3/4"

# Optics

- 20°, 40°, and 60° Field-changable reflectors

CBCP:	CR9	CR12	CR15	CR18	CR20	CR25	CR30
20°	3100	4250	5500	6030	6700	8600	11000
40°	1850	2500	3250	3600	4000	5100	6500
60°	980	1350	1750	2100	2425	3200	3700

\* Testing done at 3000K, 80 CRI.

## 1-Linear

CR20R-1



## 2-Linear

CR20R-2



## 3-Linear

CR20R-3



## 4-Linear

CR20R-4



## Photometric Data

**20° Spot Reflector** Beam Spread

Distance	Beam Spread	Footcandles						
		CR9	CR12	CR15	CR18	CR20	CR25	CR30
5'	1.7"	126	170	220	241	268	344	440
10'	3.5"	31	43	55	60	67	86	110
15'	5.3"	14	19	24	27	30	38	49
20'	7.1"	8	11	14	15	17	22	28
25'	8.8"	5	7	9	10	11	14	18
30'	10.6"	-	6	6	7	7	10	12

**40° Medium Flood Reflector** Beam Spread

Distance	Beam Spread	Footcandles						
		CR9	CR12	CR15	CR18	CR20	CR25	CR30
5'	3.6"	74	100	130	144	160	204	260
10'	7.3"	19	25	33	36	40	51	65
15'	10.9"	8	11	15	16	18	23	29
20'	14.6"	5	6	8	9	10	13	16
25'	18.2"	-	-	5	6	6	8	10
30'	22.2"	-	-	-	-	-	6	7

**60° Flood Reflector** Beam Spread

Distance	Beam Spread	Footcandles						
		CR9	CR12	CR15	CR18	CR20	CR25	CR30
5'	5.7"	39	54	70	85	97	128	148
10'	11.6"	10	14	18	21	24	32	37
15'	17.3"	5	6	8	9	11	14	16
20'	23.1"	-	5	5	5	6	8	9
25'	28.9"	-	-	-	-	5	5	6
30'	35.2"	-	-	-	-	-	-	-

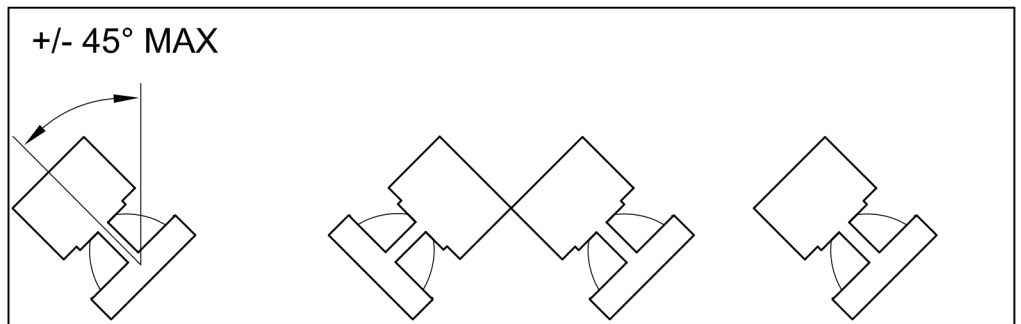
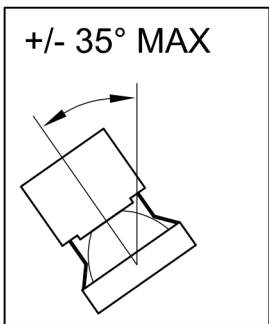
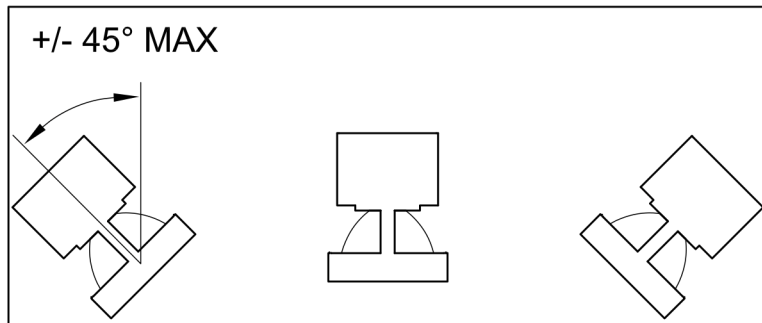
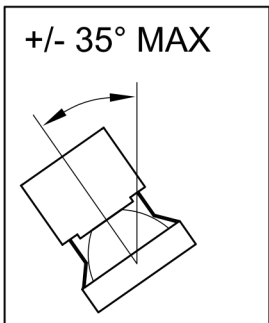
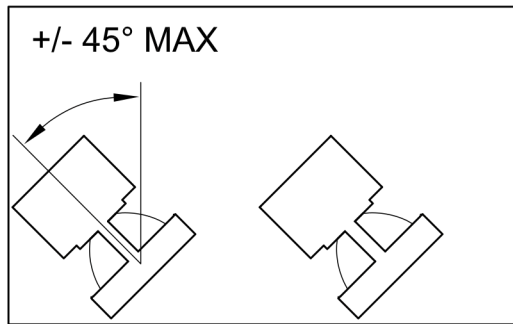
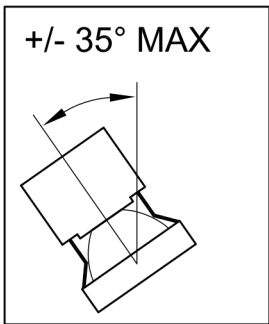
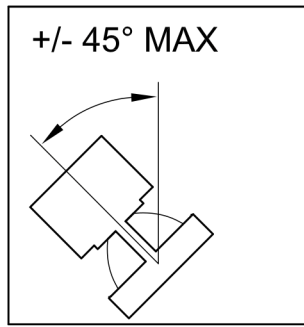
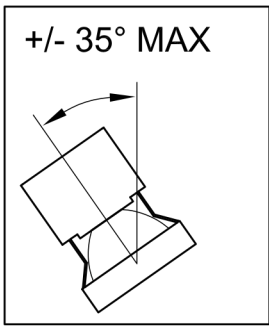

## HOW TO SPECIFY:

MODEL	LUMENS	NUMBER OF LAMPS
CR	<b>9R</b> = 900 <b>12R</b> = 1200 <b>15R</b> = 1500 <b>18R</b> = 1800 <b>20R</b> = 2000 <b>25R</b> = 2500 <b>27R</b> = 2700* <b>30R</b> = 3000** <b>35R</b> = 3500**	<b>1</b> 1-Linear <b>2</b> 2-Linear <b>3</b> 3-Linear <b>4</b> 4-Linear
CRI	COLOR TEMPERATURE	FIXTURE FINISH
80 92	<b>27</b> 2700°K <b>30</b> 3000°K <b>35</b> 3500°K <b>40</b> 4000°K <b>50</b> 5000°K <b>57</b> 5700°K <b>65</b> 6500°K	<b>B</b> Black <b>W</b> White <b>S</b> Silver <b>CC</b> Custom
TRIM FINISH	GIMBLE FINISH	VOLTAGE
<b>B</b> Black <b>W</b> White <b>S</b> Silver <b>CC</b> Custom	<b>B</b> Black <b>W</b> White <b>S</b> Silver <b>CC</b> Custom	100† 120 240 277
REFLECTOR	DIMMING †	ACCESSORIES
<b>20</b> 20° <b>40</b> 40° <b>60</b> 60°	<b>TE</b> = Trailing Edge*** <b>LE</b> = Leading Edge <b>010</b> = 0-10V <b>ND</b> = Non-Dimming <b>DMX</b> = DMX Basic <b>ECP</b> = Ecosystem premier 0.1% dim	<b>LV22</b> Louver <b>FX22-26</b> Red Filter <b>FX22-80</b> Blue Filter <b>FX22-64</b> Light Blue Filter <b>FX22-90</b> Green Filter <b>FX22-21</b> Amber <b>FX22-10</b> Yellow <b>FX22-33</b> Pink <b>DF22</b> Dichroic Color Filter <b>X00517</b> Accessory Holder

Maximum ambient temperature: 35°C  
 Maximum operating angle: 45° from vertical

\* 92 CRI Only \*\* 80 CRI Only  
 \*\*\* 277V TE Dimming available on 1800, 2500 & 3000 lumen,  
 80 CRI and 1500 & 2700 lumen, 92 CRI only.

† See "Notes on Dimming" below  
 †† Non-Dim or 0-10V dimming only

### EXAMPLE: CR-9R-2-80-35-B-B-B-120-20-LE-LV22

MODEL	LUMENS	NUMBER OF LAMPS	CRI	COLOR TEMPERATURE	FIXTURE FINISH	TRIM FINISH	GIMBLE FINISH	VOLTAGE	REFLECTOR	DIMMING	ACCESSORIES

\* For notes on dimming, please [click here](#).