

# CR140

113W 14000 LUMEN LED

MANUFACTURED IN THE UNITED STATES - IBEW



PRODUCT LISTED  
BY A NATIONALLY  
RECOGNIZED  
TESTING  
LABORATORY



The CR140 is a powerful LED fixture designed for medium to long throw applications. This efficient, 113-watt LED fixture can produce a beam that rivals line voltage PAR technology. The CR140 utilizes a Citizen CITED array that delivers a high lumen output and uniform color. The available beam angles are 12°, 19°, 33°, 40°, 48°, 55° and 64°.

The CR140 is available in Black, White, and Silver finishes. Custom colors are available upon request.

## LED SPECIFICATIONS

- Citizen CITED LED array
- **Color Temperature Options:** 2700K, 3000K, 3500K, 4000K, 5000K, 5700K
- **CRI:** 80 standard or 92 optional
- **Lumen Maintenance:** 90% of initial lumen output at 33,000 hours on LM-80 testing
- No UV or IR

CRI	TOTAL WATTAGE*	LUMEN	EFFICACY (LM/W)
80	113	14000	124
92	113	12300	109

\* Total wattage equals LED plus driver. Delivered lumen may vary depending on LED module, color temperature, optics, and accessories. Testing done with 3000K LED array.

## CONSTRUCTION

- Steel & aluminum housing with black, white or silver finish
- Internal accessory holder holds multiple accessories.
- **Weight:** 7 lbs.

## ELECTRICAL

- Integral electronic driver
- 100-277V, 50/60Hz
- Meets FCC 47 CFR Part 15/18 Requirements

## DIMMING

- **Trailing Edge (ELV):** 120V
- **Leading Edge (Triac):** 120V
- **0-10V:** 120-277V with surface mounting.
- Dims to 0.1% on 0-10V or 1% minimum on most phase dimmers
- IP (Integrated Pot) dimming available

## OPTICS

- 12°, 19°, 33° 40°, 48°, 55°, and 64° field - changeable reflectors

# CR140

113W 14000 LUMEN LED

MANUFACTURED IN THE UNITED STATES - IBEW



PRODUCT LISTED  
BY A NATIONALLY  
RECOGNIZED  
TESTING  
LABORATORY

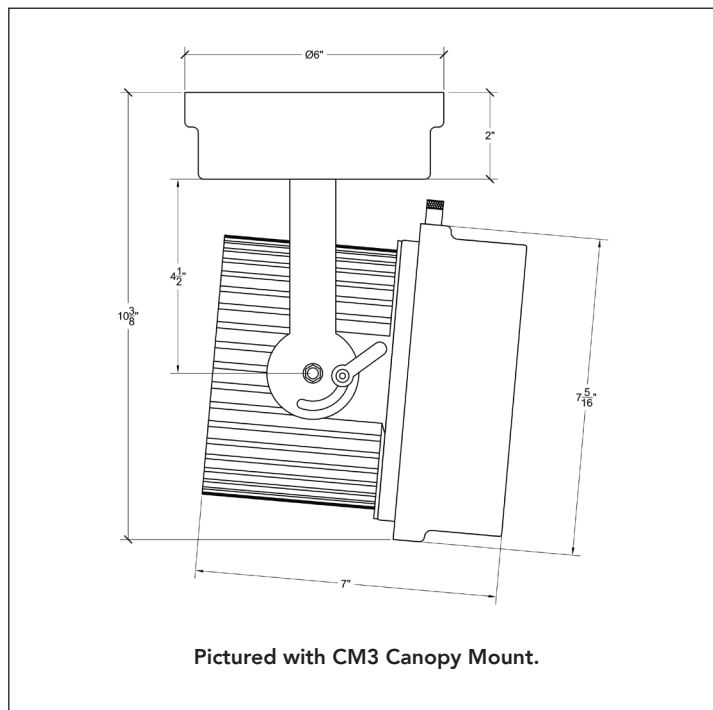
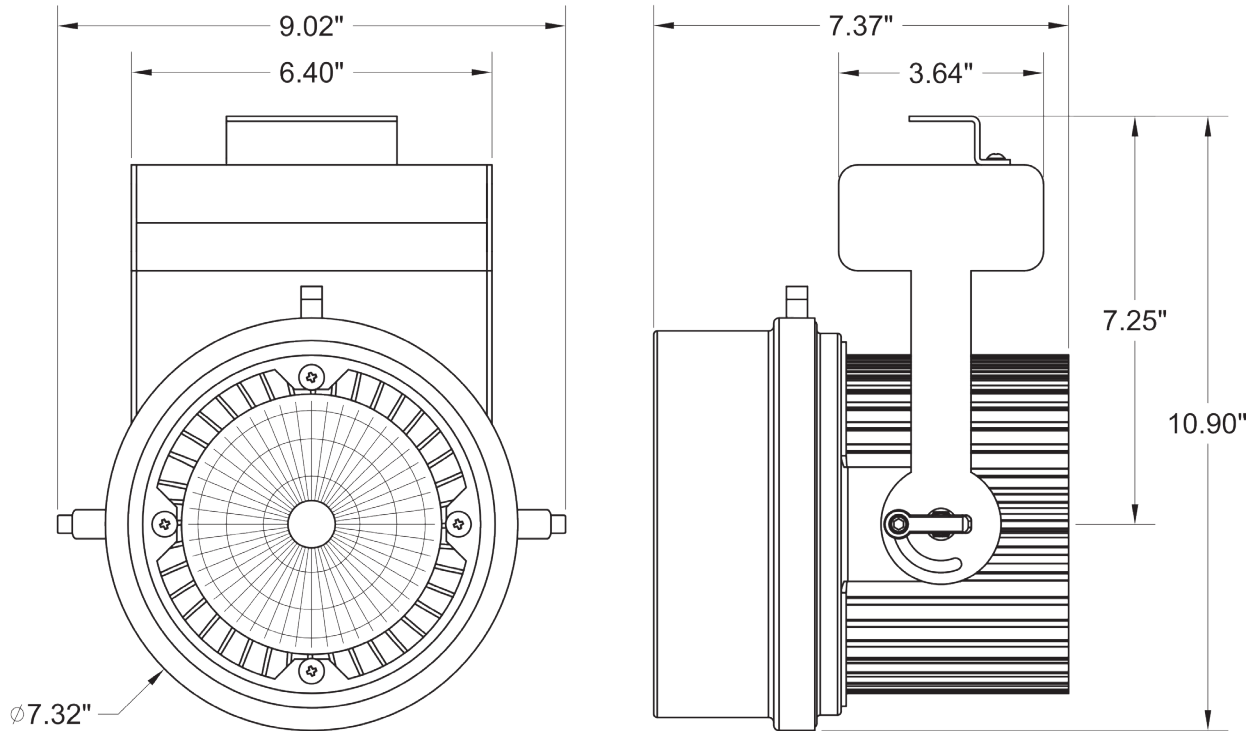

**PHOTOMETRIC DATA**

**12° Spot Reflector**

Distance	Beam Spread	Footcandles
10'	2'1"	1100
20'	4'2"	275
30'	6'4"	122
40'	8'5"	69
50'	10'6"	44

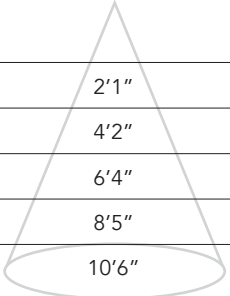

**19° Spot Reflector**

Distance	Beam Spread	Footcandles
10'	3'4"	460
20'	6'8"	115
30'	10'	51
40'	13'4"	29
50'	16'8"	18

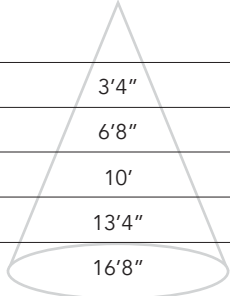

**33° Spot Reflector**

Distance	Beam Spread	Footcandles
10'	6'	224
20'	12'	56
30'	18'	25
40'	24'	14
50'	30'	9

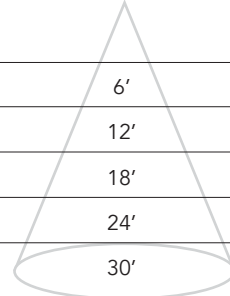

**40° Spot Reflector**

Distance	Beam Spread	Footcandles
10'	7'3"	182
20'	14'6"	46
30'	21'8"	20
40'	29'1"	11
50'	36'4"	7

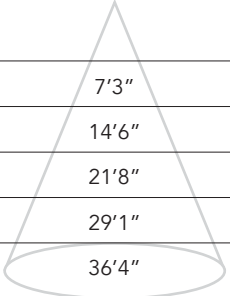

**48° Spot Reflector**

Distance	Beam Spread	Footcandles
10'	8'10"	123
20'	17'8"	31
30'	26'6"	14
40'	35'4"	8
50'	44'2"	5

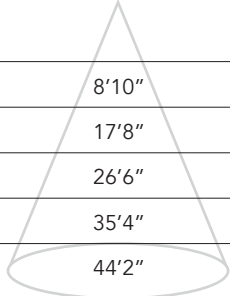

**55° Spot Reflector**

Distance	Beam Spread	Footcandles
10'	10'4"	111
20'	20'8"	28
30'	31'	12
40'	41'4"	7
50'	51'7"	4

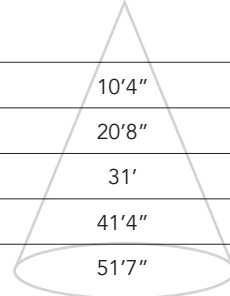

**64° Spot Reflector**

Distance	Beam Spread	Footcandles
10'	12'7"	77
20'	25'2"	19
30'	37'9"	9
40'	50'4"	5
50'	64'1"	3

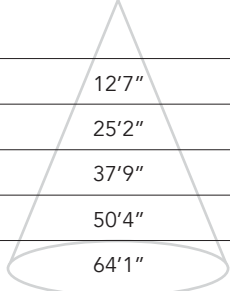

# CR140

## 113W 14000 LUMEN LED

MANUFACTURED IN THE UNITED STATES - IBEW



PRODUCT LISTED  
BY A NATIONALLY  
RECOGNIZED  
TESTING  
LABORATORY

### MOUNTING OPTIONS

DT2 2-Circuit track adapter for SpecTrac Databus.120V.

HDT2 Track adapter for SpecTrack 2-Circuit data track. 277V.

T1 Track Adapter for commercial grade 1 & 2 circuit track. 120V. For use with larger, heavier fixtures.

TA2 Track adapter for G-Series specification grade 2-circuit track. 120V.

HTA2 Track adapter for G-Series specification grade 2-circuit track. 277V.

TA3 Track adapter for G-Series specification grade 3-circuit track. 120V.

CM4 Canopy Mount

CM3 Canopy Mount (driver in canopy)

US1 6-5/8" x 1-1/2" Unistrut Adapter

TB8 8" x 8" Portable table base for floor and table use

MN Medium duty pipe clamp for small to large fixtures. For pipes up to 2" O.D.

PC9M Heavy duty pipe clamp for large, heavy fixtures. For pipes up to 2" O.D.

### EXTENSION WANDS

SP 12	12" Stem
SP 18	18" Stem
SP 24	24" Stem
SP X	Custom Length

### ACCESSORIES

LV9	Louver
LV9BD	Louver (for use with BD9)
BD9	Barndoor
HD9	Hood
SH9	Sparkle Hood
XH9	Cross Baffle Hood
CF9	Color Frame
GF9	Glass Color Filter
DF9	Dichroic Color Filter
GF9-600	5° x 50° Linear Lens
GF9-601	Beam Softener
GF9-673	50° x 50° Spread Lens
CC18	Coiled Cord
SC-24	Safety Cable

### NOTES ON DIMMING

Visit [tslight.com/resources](https://tslight.com/resources) or scan the QR Code.



**SPECIFY:**

MODEL	LED MODULE	COLOR TEMPERATURE
CR140	80 92	27 = 2700K 30 = 3000K 35 = 3500K 40 = 4000K 50 = 5000K ** 57 = 5700K **
FINISH	VOLTAGE	OPTICS
B = Black W = White S = Silver CC = Custom Color	120 277	12 = 12° Degree 19 = 19° Degree 33 = 33° Degree 40 = 40° Degree 48 = 48° Degree 55 = 55° Degree 64 = 64° Degree
MOUNTING	DIMMING †	ACCESSORIES
See Mounting Options for Ordering Codes	PH = Phase Dimming (Leading/Trailing Edge) * 010 = 0-10V Dimming IP = Integral Pot	See Accessory Options for Ordering Codes

Maximum Ambient Temperature: 35°C  
Maximum Operating Angle: 45° from vertical

\* 120V Only

† See "Notes on Dimming"  
\*\* 80 CRI Only

**ORDERING INFORMATION**

PROJECT:	
LOCATION:	
QUANTITY:	
CONTACT:	
PHONE:	
EMAIL:	

**EXAMPLE:** CR140-9230-B-120-12-DT2-PH

MODEL	LED MODULE	COLOR TEMPERATURE	FINISH	VOLTAGE	OPTICS	MOUNTING	DIMMING	ACCESSORIES
CR140								